



# 104-716

## 204 air-716 air

Models 40xxx  
41xxx  
50xxx  
51xxx

- de** Originalgebrauchsanleitung
- en** Operating instructions
- fr** Mode d'emploi
- es** Manual de instrucciones
- it** Manuale d'uso
- pt** Manual de utilização
- nl** Gebruiksaanwijzing







**Lesen Sie aufmerksam vor Inbetriebnahme des Aktenvernichters die Gebrauchsanleitung und Sicherheitshinweise! Die Hinweise müssen angewendet werden! Bewahren Sie diese für den späteren Gebrauch auf.**

- Den Aktenvernichter ausschließlich **nur stehend** lagern, transportieren und betreiben!
- Am Aktenvernichter nur Flüssigkeiten und Gase verwenden, welche den DAHLE-Richtlinien entsprechen!
- Der Aktenvernichter muß in geschlossenen Räumen bei einer Temperatur von 15°C bis 32°C (59°F - 90°F) und einer nichtkondensierenden Luftfeuchtigkeit von 15% bis 95% betrieben werden!
- Der Aktenvernichter darf nicht in der Nähe einer Wärmequelle aufgestellt werden!
- Den Aktenvernichter standsicher auf den Boden und in einem Abstand von 100 mm zur Wand aufstellen, Feststellbremsen betätigen und mit dem eventuell beiliegendem Montageset befestigen!
- Stauwärme vermeiden!
- Die schutzgeerdete Netzsteckdose muß jederzeit leicht zugänglich sein!
- Nur eine von der Firma DAHLE beigelegte, unbeschädigte Netzanschlussleitung verwenden!
- Die Kurzschlussicherheit der Gebäudeinstallation ist sicherzustellen: max. 16A (US max. 20A)!
- Nicht in der Nähe von brennbaren Flüssigkeiten und Gasen verwenden!
- Nicht in der Nähe von ätzenden Stoffen verwenden!
- Nicht der Nässe aussetzen!
- Das Gerät darf nicht geöffnet werden!
- Automatischer Anlauf!
- Den Aktenvernichter nicht im Leerlauf betreiben!
- Bei Nichtgebrauch Aktenvernichter am Hauptschalter ausschalten!
- Den Aktenvernichter nur in einwandfreiem Zustand betreiben unter Berücksichtigung der Gebrauchsanleitung, den üblichen Vorschriften und Richtlinien sowie den geltenden Sicherheitsbestimmungen und Unfallverhütungsvorschriften. Bei auftretenden Störungen ist der Aktenvernichter umgehend außer Betrieb zu setzen!
- Das Gerät ist nicht zur Benutzung von Personen bestimmt (einschließlich Kinder) mit eingeschränkten physischen, sensorischen oder geistigen Fähigkeiten oder mangelnder Erfahrung und Wissen, es sei denn, sie arbeiten unter Aufsicht oder erhalten eine ausführliche Anleitung zur Benutzung des Gerätes von einer Person die für die Sicherheit verantwortlich ist.



- 1 - Sicherheits-Vorschriften müssen angewendet werden!
- 2 - **Lesen Sie aufmerksam vor Inbetriebnahme des Aktenvernichters die Gebrauchsanleitung und Sicherheitshinweise!**
- 3 - Dieser Aktenvernichter ist nicht zur Benutzung durch Kinder bestimmt (das Produkt ist kein Spielzeug)!
- 4 - Berühren Sie die Papierzuführung nicht mit den Händen!
- 5 - Berühren Sie die Papierzuführung nicht mit Kleidungsstücken!
- 6 - Berühren Sie die Papierzuführung nicht mit Haaren!
- 7 - Vor Wartungsarbeiten den Aktenvernichter von der Stromversorgung trennen!
- 8 - Beim Vernichten von CD/DVD ist eine Schutzbrille zu tragen!
- 9 - Büro- und Heftklammern vor dem Vernichtungsvorgang entfernen!  
(Geräte der Sicherheitsstufe P6 und P7)

**Warnhinweise beachten!**

- <sup>1</sup> - Betriebslautstärke im Leerlauf (nach DIN)
- <sup>2</sup> - Aktenvernichter in Bereitschaft
- <sup>3</sup> - Aktenvernichter in Betrieb
- <sup>4</sup> - Automatischer Anlauf
- <sup>5</sup> - Ölen (Nur DAHLE-ÖL verwenden!)
- <sup>6</sup> - Entsorgen Sie den Aktenvernichter fachgerecht und umweltgerecht, bei einer autorisierten Sammelstelle. Geben Sie keine Teile des Aktenvernichters oder der Verpackung in den Hausmüll

**Bestimmungsgemäße Verwendung, Gewährleistung**

Der Aktenvernichter ist zum Vernichten von Papier bestimmt.

Je nach Modellvariante kann außerdem eine geringe Menge folgender Materialien vernichtet werden:

- CD's/DVD's, Scheck- und Kreditkarten (siehe Technische Daten)
- die in Papierdokumenten, in anwendungsüblichem Umfang, vorhandenen Heft- und Büroklammern (Ausnahme: Geräte der Sicherheitsstufe P6 und P7)

Verschleiß, Schäden durch unsachgemäßen Gebrauch sowie Eingriffe von dritter Stelle fallen weder unter die Gewährleistung noch unter die Garantie

Der Aktenvernichter ist für den Betrieb im privaten Bereich und normaler Büroumgebung konzipiert.

Bzgl. der unter technische Daten angegebenen Blattleistung gelten folgende Rahmenbedingungen: Maximale Anzahl von Blättern, die in einem Durchgang unter folgenden Bedingungen geschnitten werden: Neue ggfs. geölte Schneidwalzen, kalter Motor, Stromversorgung mit Nennspannung und Nennfrequenz (230V/50Hz; 120V/60Hz). Abweichungen können zu einer geringeren Blattleistung und zu erhöhten Laufgeräuschen führen. Die Blätter werden mittig und längs unter 90° zugeführt. Je nach Papiereigenschaften und Zuführung kann die Blattleistung ebenfalls variieren.

**Technische Änderungen vorbehalten!**

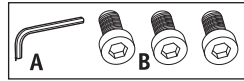
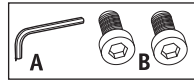
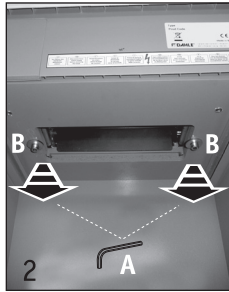
**Transportsicherung entfernen!**

1. Feststellbremsen betätigen! Öffnen Sie vor der ersten Inbetriebnahme die Tür, Papierauffangbehälter entnehmen.
2. Entfernen Sie die Schrauben der Transportsicherung (Einschubbereich Papierauffangbehälter) aus der Bodenplatte unterhalb des Schneidwerks, Papierauffangbehälter wieder einschieben und Tür schließen.
3. Bei jeder Standortveränderung ist die Transportsicherung wieder einzubringen.

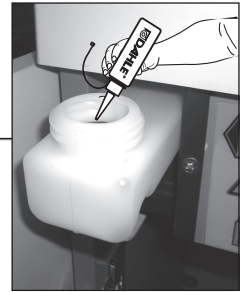

1. Ölen Sie die Schneidwalzen mit DAHLE-Aktenvernichter-Öl (nur Partikelschnitt P5, P6 und P7)!
2. Befüllen Sie den Öltank mit DAHLE-Aktenvernichter-ÖL!



Je nach Modellvariante enthält Ihr Aktenvernichter nicht alle möglichen Komponenten und Funktionen.

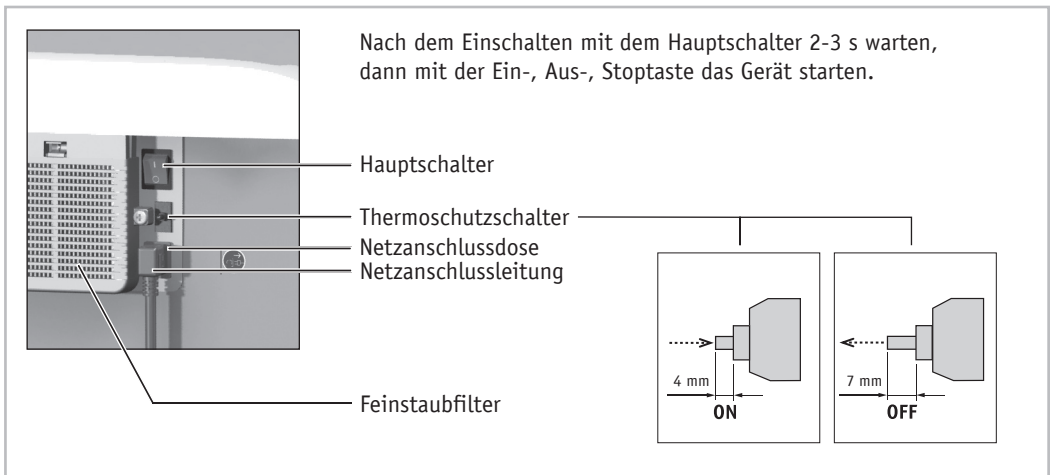
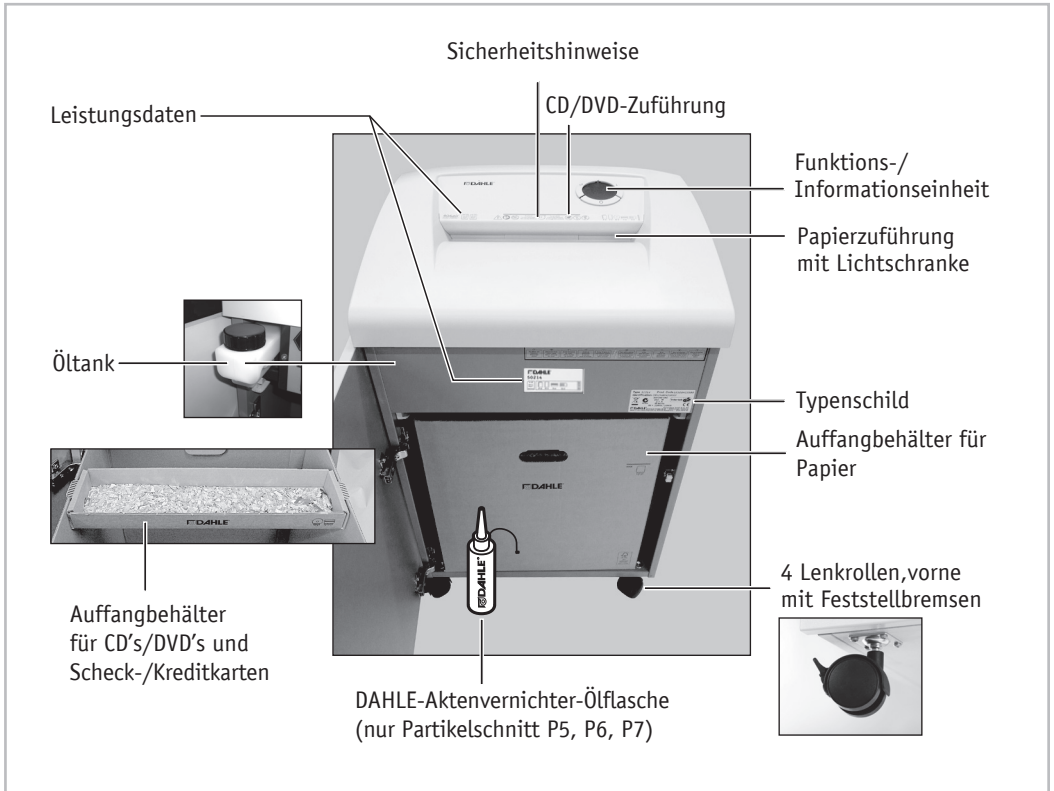



Je nach Modellvariante enthält Ihr Aktenvernichter nicht alle möglichen Komponenten und Funktionen.

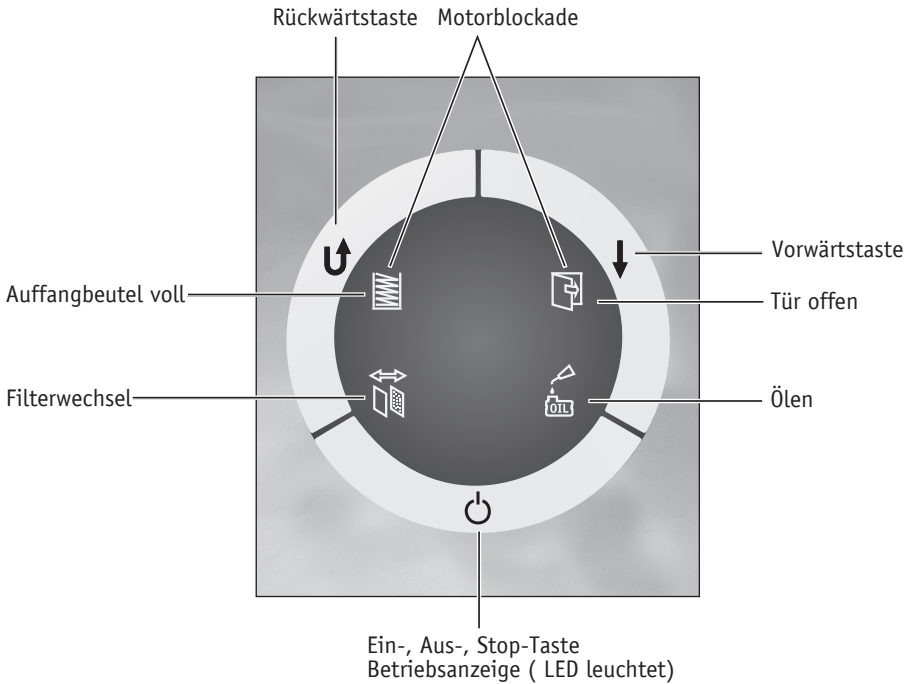









Type  
Prod. Code

XXX-XXX V  
XX Hz







- Überprüfen Sie, dass die Spannung und Netzfrequenz Ihres Stromnetzes mit den Angaben auf dem Typenschild übereinstimmen.













































							Sicherheitsstufen nach DIN 66399*				
							P	F	0	T	E
			DIN A4- 70g/m <sup>2</sup>	DIN A4- 80g/m <sup>2</sup>							
104	40206	240	19	16	5,8mm	-	P-2	-	0-2	T-2	E-2
106	40306	260	27	22	5,8mm	-	P-2	-	0-2	T-2	E-2
110	40406	260	29	23	5,8mm	-	P-2	-	0-2	T-2	E-2
114	40506	310	43	35	5,8mm	-	P-2	-	0-2	T-2	E-2
116	40606	400	45	36	5,8mm	-	P-2	-	0-2	T-2	E-2
104 air	41206	240	19	16	5,8mm	-	P-2	-	0-2	T-2	E-2
106 air	41306	260	27	22	5,8mm	-	P-2	-	0-2	T-2	E-2
110 air	41406	260	29	23	5,8mm	-	P-2	-	0-2	T-2	E-2
114 air	41506	310	43	35	5,8mm	-	P-2	-	0-2	T-2	E-2
116 air	41606	400	45	36	5,8mm	-	P-2	-	0-2	T-2	E-2
203	40104	220	15	13	3,9mm	-	P-2	-	-	T-2	E-2
204	40204	240	17	14	3,9mm	-	P-2	-	-	T-2	E-2
206	40304	260	23	18	3,9mm	-	P-2	-	0-2	T-2	E-2
210	40404	260	24	19	3,9mm	-	P-2	-	0-2	T-2	E-2
214	40504	310	33	26	3,9mm	-	P-2	-	0-2	T-2	E-2
216	40604	400	35	28	3,9mm	-	P-2	-	0-2	T-2	E-2
204 air	41204	240	17	14	3,9mm	-	P-2	-	-	T-2	E-2
206 air	41304	260	23	18	3,9mm	-	P-2	-	0-2	T-2	E-2
210 air	41404	260	24	19	3,9mm	-	P-2	-	0-2	T-2	E-2
214 air	41504	310	33	26	3,9mm	-	P-2	-	0-2	T-2	E-2
216 air	41604	400	35	28	3,9mm	-	P-2	-	0-2	T-2	E-2
306	50310	260	19-21	18-20	-	5,0x50mm	P-3	-	0-3	T-3	E-2
310	50410	260	19-21	18-20	-	5,0x50mm	P-3	-	0-3	T-3	E-2
306 air	51310	260	19-21	18-20	-	5,0x50mm	P-3	-	0-3	T-3	E-2
310 air	51410	260	19-21	18-20	-	5,0x50mm	P-3	-	0-3	T-3	E-2
403	50114	240	8-10	7-9	-	4,0x40,0mm	P-4	F-1	-	T-4	E-3
404	50214	240	8-10	7-9	-	4,0x40,0mm	P-4	F-1	-	T-4	E-3
406	50314	260	17-19	15-17	-	4,0x40,0mm	P-4	F-1	0-3	T-4	E-3
410	50414	260	17-19	15-17	-	4,0x40,0mm	P-4	F-1	0-3	T-4	E-3
410 L plus	50464	310	25-27	24-26	-	4,0x40,0mm	P-4	F-1	0-3	T-4	E-3
414	50514	310	25-27	24-26	-	4,0x40,0mm	P-4	F-1	0-3	T-4	E-3
416	50564	400	19-21	18-20	-	4,0x40,0mm	P-4	F-1	0-3	T-4	E-3
404 air	51214	240	8-10	7-9	-	4,0x40,0mm	P-4	F-1	-	T-4	E-3
406 air	51314	260	17-19	15-17	-	4,0x40,0mm	P-4	F-1	0-3	T-4	E-3
410 air	51414	260	17-19	15-17	-	4,0x40,0mm	P-4	F-1	0-3	T-4	E-3
410 L plus air	51464	310	25-27	24-26	-	4,0x40,0mm	P-4	F-1	0-3	T-4	E-3



		220-240V 50-60Hz	100-120V 50-60Hz				
	Geschwindigkeit m/min				Maße H x B x T mm	Auffang- volumen l	Gewicht kg
<=47dB/A	6,0	350W	400W	-	705x430x350	40	25,0
<=47dB/A	4,0	650W	680W	-	865x545x435	60	43,0
<=51dB/A	4,4	650W	680W	-	944x545x435	100	45,0
<=46dB/A	4,5	900W	900W	-	890x734x511	140	64,0
<=50dB/A	6,0	1650W	1650W	-	960x734x511	160	92,0
<=47dB/A	6,0	350W	400W	-	705x430x350	40	26,0
<=47dB/A	4,0	650W	680W	-	865x545x435	60	44,0
<=51dB/A	4,4	650W	680W	-	944x545x435	100	46,0
<=46dB/A	4,5	900W	900W	-	890x734x511	140	65,0
<=50dB/A	6,0	1650W	1650W	-	960x734x511	160	93,0
<=49dB/A	6,0	350W	400W	-	628x430x350	30	22,5
<=46dB/A	6,0	350W	400W	-	705x430x350	40	25,0
<=46dB/A	4,0	650W	680W	-	865x545x435	60	43,0
<=51dB/A	4,4	650W	680W	-	944x545x435	100	45,0
<=47dB/A	4,5	900W	900W	-	890x734x511	140	64,0
<=49dB/A	6,0	1650W	1650W	-	960x734x511	160	92,0
<=46dB/A	6,0	350W	400W	-	705x430x350	40	26,0
<=46dB/A	4,0	650W	680W	-	865x545x435	60	44,0
<=51dB/A	4,4	650W	680W	-	944x545x435	100	46,0
<=47dB/A	4,5	900W	900W	-	890x734x511	140	65,0
<=49dB/A	6,0	1650W	1650W	-	960x734x511	160	93,0
<=46dB/A	4,5	650W	680W	-	865x545x435	60	43,0
<=46dB/A	4,5	650W	680W	-	944x545x435	100	45,0
<=46dB/A	4,5	650W	680W	-	865x545x435	60	43,5
<=46dB/A	4,5	650W	680W	-	944x545x435	100	45,5
<=44dB/A	6,5	350W	400W	-	628x430x350	30	23,0
<=46dB/A	6,5	350W	400W	-	705x430x350	40	25,0
<=46dB/A	4,5	650W	680W	-	865x545x435	60	43,0
<=52dB/A	4,5	650W	680W	-	944x545x435	100	45,0
<=52dB/A	4,7	900W	900W	-	944x545x435	100	54,5
<=52dB/A	4,7	900W	900W	-	890x734x511	140	64,0
<=52dB/A	5,7	900W	900W	-	960x734x511	160	68,5
<=46dB/A	6,5	350W	400W	-	705x430x350	40	25,5
<=46dB/A	4,5	650W	680W	-	865x545x435	60	43,5
<=52dB/A	4,5	650W	680W	-	944x545x435	100	45,5
<=52dB/A	4,7	900W	900W	-	944x545x435	100	55,0



		Sicherheitsstufen nach DIN 66399*									
							P	F	O	T	E
			DIN A4-70g/m <sup>2</sup>	DIN A4-80g/m <sup>2</sup>							
414 air	51514	310	25-27	24-26	-	4,0x40,0mm	P-4	F-1	0-3	T-4	E-3
416 air	51564	400	19-21	18-20	-	4,0x40,0mm	P-4	F-1	0-3	T-4	E-3
504	40222	240	6	5	-	2,0x15,0mm	P-5	F-2	-	T-5	E-4
506	50322	260	12-14	11-13	-	2,0x15,0mm	P-5	F-2	-	T-5	E-4
510	50422	260	12-14	11-13	-	2,0x15,0mm	P-5	F-2	-	T-5	E-4
510 L plus	50472	310	18-20	17-19	-	2,0x15,0mm	P-5	F-2	0-4	T-5	E-4
514	50522	310	18-20	17-19	-	2,0x15,0mm	P-5	F-2	0-4	T-5	E-4
516	50572	400	14-16	13-15	-	2,0x15,0mm	P-5	F-2	0-4	T-5	E-4
504 air	41222	240	6	5	-	2,0x15,0mm	P-5	F-2	-	T-5	E-4
506 air	51322	260	12-14	11-13	-	2,0x15,0mm	P-5	F-2	-	T-5	E-4
510 air	51422	260	12-14	11-13	-	2,0x15,0mm	P-5	F-2	-	T-5	E-4
510 L plus air	51472	310	18-20	17-19	-	2,0x15,0mm	P-5	F-2	0-4	T-5	E-4
514 air	51522	310	18-20	17-19	-	2,0x15,0mm	P-5	F-2	0-4	T-5	E-4
516 air	51572	400	14-16	13-15	-	2,0x15,0mm	P-5	F-2	0-4	T-5	E-4
604	40230	240	3	2	-	0,8x12,0mm	P-6	F-3	-	-	-
606	40330	260	6	5	-	0,8x12,0mm	P-6	F-3	-	T-6	-
610	40430	260	7	6	-	0,8x12,0mm	P-6	F-3	-	T-6	-
614	40530	310	11	9	-	0,8x12,0mm	P-6	F-3	-	T-6	-
616	40630	400	14	11	-	0,8x12,0mm	P-6	F-3	-	T-6	-
604 air	41230	240	3	2	-	0,8x12,0mm	P-6	F-3	-	-	-
606 air	41330	260	6	5	-	0,8x12,0mm	P-6	F-3	-	T-6	-
610 air	41430	260	7	6	-	0,8x12,0mm	P-6	F-3	-	T-6	-
614 air	41530	310	11	9	-	0,8x12,0mm	P-6	F-3	-	T-6	-
616 air	41630	400	14	11	-	0,8x12,0mm	P-6	F-3	-	T-6	-
706	40334	260	6	5	-	1,0x4,7mm	P-7	F-3	-	T-6	-
710	40434	260	6	5	-	1,0x4,7mm	P-7	F-3	-	T-6	-
710 L plus	40484	310	9	7	-	1,0x4,7mm	P-7	F-3	-	T-6	-
714	40534	310	9	7	-	1,0x4,7mm	P-7	F-3	-	T-6	-
716	40634	400	12	9	-	1,0x4,7mm	P-7	F-3	-	T-6	-
706 air	41334	260	6	5	-	1,0x4,7mm	P-7	F-3	-	T-6	-
710 air	41434	260	6	5	-	1,0x4,7mm	P-7	F-3	-	T-6	-
714 air	41534	310	9	7	-	1,0x4,7mm	P-7	F-3	-	T-6	-
716 air	41634	400	12	9	-	1,0x4,7mm	P-7	F-3	-	T-6	-

	Geschwindigkeit m/min	220-240V 50-60Hz	100-120V 50-60Hz		Maße H x B x T mm	Auffang- volumen l	Gewicht kg
							
<=52dB/A	4,7	900W	900W	-	890x734x511	140	64,5
<=52dB/A	5,7	900W	900W	-	960x734x511	160	69,0
<=47dB/A	6,0	350W	400W		705x430x350	40	25,0
<=46dB/A	4,4	650W	680W		865x545x435	60	44,0
<=53dB/A	4,4	650W	680W		944x545x435	100	46,0
<=53dB/A	4,8	900W	900W		944x545x435	100	59,0
<=52dB/A	4,8	900W	900W		890x734x511	140	68,5
<=53dB/A	5,6	900W	900W		960x734x511	160	75,0
<=47dB/A	6,0	350W	400W		705x430x350	40	26,0
<=46dB/A	4,4	650W	680W		865x545x435	60	43,0
<=53dB/A	4,4	650W	680W		944x545x435	100	47,0
<=53dB/A	4,8	900W	900W		944x545x435	100	60,0
<=53dB/A	4,8	900W	900W		890x734x511	140	69,5
<=53dB/A	5,6	900W	900W		960x734x511	160	76,0
<=50dB/A	6,0	350W	400W		705x430x350	40	25,0
<=47dB/A	3,5	650W	680W		865x545x435	60	43,0
<=52dB/A	4,3	650W	680W		944x545x435	100	45,0
<=50dB/A	4,5	900W	900W		890x734x511	140	64,0
<=50dB/A	4,0	1650W	1650W		960x734x511	160	92,0
<=50dB/A	6,0	350W	400W		705x430x350	40	26,0
<=47dB/A	3,5	650W	680W		865x545x435	60	44,0
<=52dB/A	4,3	650W	680W		944x545x435	100	46,0
<=50dB/A	4,5	900W	900W		890x734x511	140	65,0
<=50dB/A	4,0	1650W	1650W		960x734x511	160	93,0
<=50dB/A	6,5	650W	680W		865x545x435	60	43,0
<=52dB/A	6,5	650W	680W		944x545x435	100	45,0
<=52dB/A	7,0	900W	900W		944x545x435	100	60,0
<=52dB/A	7,0	900W	900W		890x734x511	140	64,0
<=52dB/A	8,0	1650W	1650W		960x734x511	160	92,0
<=50dB/A	6,5	650W	680W		865x545x435	60	44,0
<=52dB/A	6,5	650W	680W		944x545x435	100	46,0
<=52dB/A	7,0	900W	900W		890x734x511	140	65,0
<=52dB/A	8,0	1650W	1650W		960x734x511	160	93,0



1.

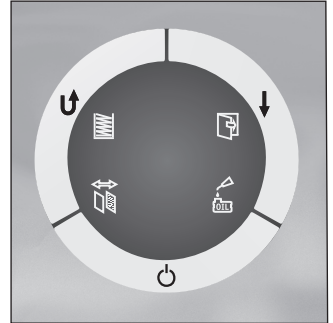

### Bitte beachten Sie die Sicherheitshinweise.

1. Vor Benutzung des Aktenvernichters, prüfen Sie bitte die Position des Auffangbehälters für CD's/ DVD's und Scheck-/Kreditkarten.
2. Schließen Sie die Tür des Aktenvernichters.
3. Verbinden Sie die mitgelieferte Netzanschlussleitung mit dem Aktenvernichter und einer Netzsteckdose. Schalten Sie den Hauptschalter ein. Nach dem Einschalten mit dem Hauptschalter 2-3 Sekunden warten.
4. Schalten Sie den Aktenvernichter an der Ein-, Aus-, Stop-Taste ein.

1.1

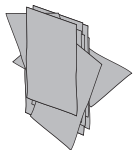

O.K.



### 1. Maximale Blattanzahl unter Technische Daten beachten!

2. Führen Sie das Papier in die Mitte der Papierzuführung ein, die eingebaute Lichtschranke startet den Aktenvernichter automatisch.
3. Nachdem die Papierzuführung wieder frei ist, schaltet sich der Aktenvernichter automatisch ab und geht in Betriebsbereitschaft.
4. **Dauervorlauf** - Nach längerer Betätigung (ca. 5 sec.) der Vorwärtstaste geht der Aktenvernichter in den Dauervorlauf.
5. Wird die Papierzufuhr 15 Sekunden unterbrochen, schaltet sich der Dauervorlauf ab.



Je nach Modellvariante enthält Ihr Aktenvernichter nicht alle möglichen Komponenten und Funktionen.

2.

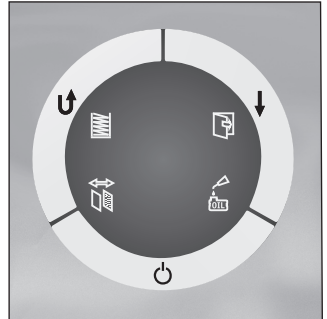
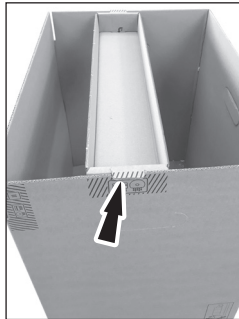
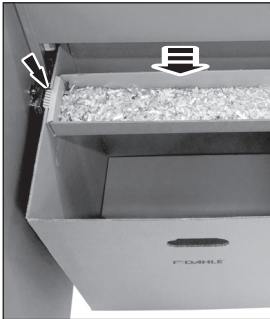

**Bitte beachten Sie die Sicherheitshinweise: Beim Vernichten von CD/DVD ist eine Schutzbrille zu tragen!**

1. Vor Benutzung des Aktenvernichters, prüfen Sie bitte die Position des Auffangbehälters für CD's/ DVD's und Scheck-/Kreditkarten.
2. Schließen Sie die Tür des Aktenvernichters.
3. Schalten Sie den Aktenvernichter an der Ein-, Aus-, Stop-Taste ein.

2.1



1. Führen Sie die CD's, DVD's oder Scheck-/Kreditkarten in die Mitte der Zuführung ein und halten Sie die Vorwärtstaste gedrückt.
2. Nachdem die CD/DVD-Zuführung wieder frei ist, schaltet sich der Aktenvernichter automatisch ab und geht in Betriebsbereitschaft.



Je nach Modellvariante enthält Ihr Aktenvernichter nicht alle möglichen Komponenten und Funktionen.

## DAHLE CleanTEC®

### Dahle Feinstaubfilter wechseln

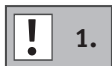

1.

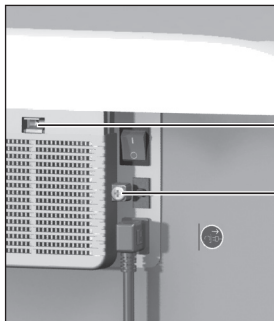
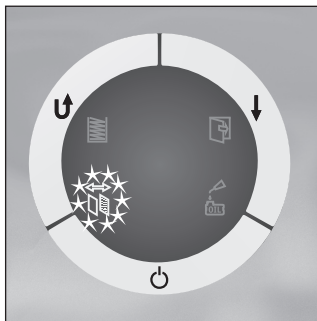

Verrastung

Schraube

1. Die Anzeige Filterwechsel (**DAHLE-Feinstaubfilter wechseln!**) leuchtet im Bedienfeld auf.
2. Trennen Sie die Netzanschlussleitung von der Netzsteckdose.
3. Wechseln Sie den Feinstaubfilter an der Rückseite des Gerätes.
  - A. Schraube lösen
  - B. Verrastung drücken und Deckel abnehmen
  - C. Filter entnehmen und entsorgen. Unbedingt wieder **DAHLE-Feinstaub-Filter** einsetzen!
  - D. Deckel schließen
  - E. Schraube festziehen
4. Verbinden Sie die Netzanschlussleitung mit der Netzsteckdose, schalten Sie den Hauptschalter und die Ein-, Aus-, Stop-Taste ein.
5. Filterwechselanzeige zurücksetzen: Halten Sie ca. 5 Sekunden gleichzeitig die Vor- und Rückwärtstaste gedrückt.

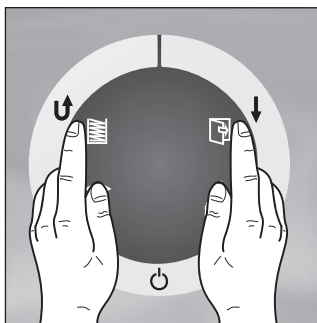

Wir übernehmen keine Haftung für unsachgemäße Anwendung des DAHLE-Feinstaubfilters und unterlassenem DAHLE-Feinstaubfilterwechsel.

Der gebrauchte DAHLE-Feinstaubfilter kann im Hausmüll entsorgt werden.

Die Feinstaubpartikel sind im DAHLE-Feinstaubfilter gebunden. Bitte entsorgen Sie den DAHLE-Feinstaubfilter unzugänglich für Kinder.



Je nach Modellvariante enthält Ihr Aktenvernichter nicht alle möglichen Komponenten und Funktionen.

## Automatisches Ölen (nur Partikelschnitt P5, P6 und P7)

Öltank mit DAHLE-Aktenvernichter-Öl auffüllen.

Integrierter Öltank für eine geregelte, automatische Ölung der Walzen.

 2.

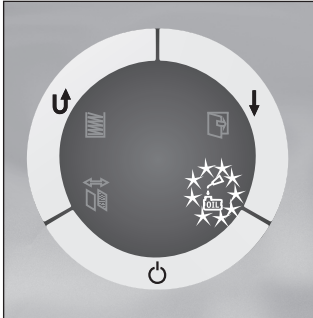

Befüllen Sie den integrierten Öltank im Aktenvernichter bei Anzeige im Display.

1. Schalten Sie den Aktenvernichter an der Ein-, Aus-, Stop-Taste aus.
2. Öffnen Sie die Tür, im Schrank befindet sich der integrierte Öltank, öffnen Sie die Verschlußkappe.
3. **Öltank mit Öl** befüllen (DAHLE-Aktenvernichter-Öl verwenden!) und wieder verschließen.



Je nach Modellvariante enthält Ihr Aktenvernichter nicht alle möglichen Komponenten und Funktionen.

Auffangbehälter voll - Die LED blinkt.

! 3.

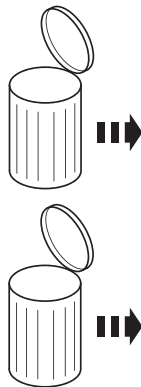
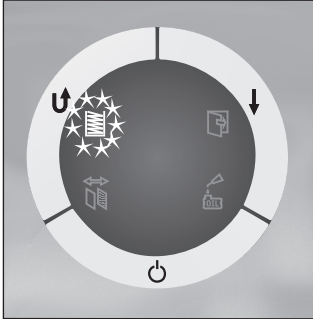

1. Bei vollem Auffangbehälter wird der Schneidvorgang gestoppt, dieses wird optisch angezeigt.
2. Schalten Sie den Hauptschalter aus und trennen Sie die Netzanschlussleitung von der Netzsteckdose.
3. Auffangbehälter entnehmen, entleeren und einsetzen.
4. Verbinden Sie die Netzanschlussleitung mit der Netzsteckdose und schalten Sie den Hauptschalter ein.





Je nach Modellvariante enthält Ihr Aktenvernichter nicht alle möglichen Komponenten und Funktionen.

**Automatische Motorabschaltung** - Die LED's für Füllstand und Tür blinken.

! 4.

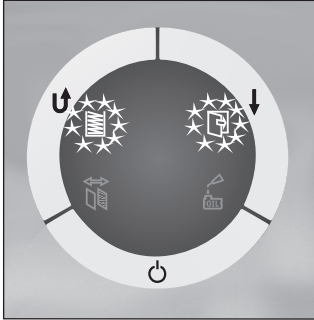

1. Automatische Motorabschaltung bei:
  - Überhitzung des Motors
  - Papierstau

**Tür offen** - Die LED blinkt.

! 5.

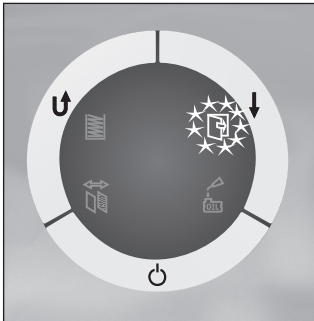

1. Bei offener Tür wird der Schneidvorgang gestoppt und die LED blinkt, schließen Sie die Tür.



Je nach Modellvariante enthält Ihr Aktenvernichter nicht alle möglichen Komponenten und Funktionen.

? 1.

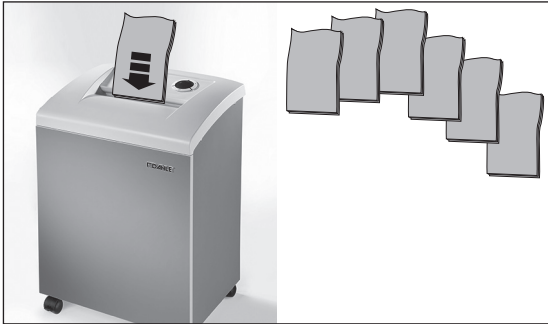

Der Aktenvernichter schaltet nach längerem Betrieb und/oder Überlastung automatisch zum Abkühlen ab.

? 2.



Thermoschutzschalter

#### Der Schneidvorgang wird nicht gestartet:

- Netzanschlussleitung nicht verbunden mit der Netzsteckdose
- Haupschalter nicht an?
- Ein-, Aus-, Stop-Taste nicht angeschaltet?
- Tür offen
- Auffangbehälter voll
- Gerät überlastet/überhitzt?
- Thermoschutzschalter OFF?

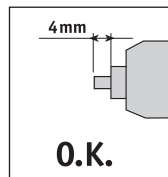
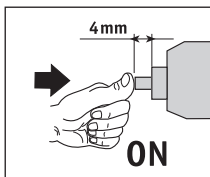
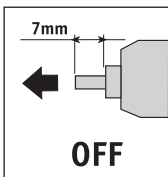

Bringen Sie den Thermoschutzschalter in die richtige Position - ON.

Je nach Modellvariante enthält Ihr Aktenvernichter nicht alle möglichen Komponenten und Funktionen.

3.

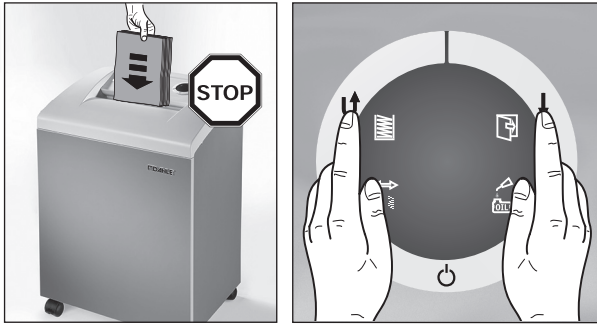

1. Ist die Blattanzahl zu hoch, wird der Schneidvorgang gestoppt.
2. Das Schneidwerk läuft selbstständig kurz rückwärts und das Papier wird herausgeschoben.
3. **ACHTUNG, Vor- und Rückwärtsschalter nicht wechselweise betätigen, damit das Schneidwerk nicht beschädigt wird!**

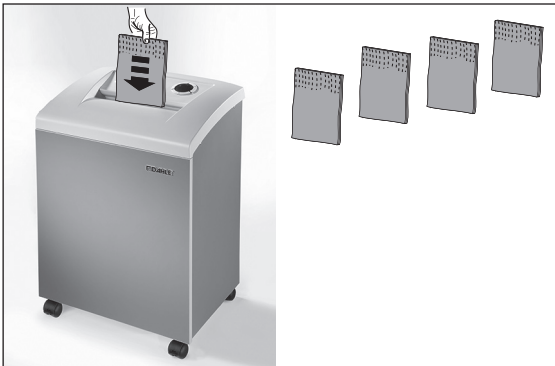

4. Bei weiterhin feststehendem Papier, betätigen Sie kurz die Rücklauttaste.
5. Verringern Sie die Blattanzahl durch Entnehmen oder Abreißen.
6. Nach dem erneuten Einführen des Papiers startet der Schneidvorgang automatisch, ansonsten betätigen Sie die Vorwärtstaste.

#### **706, 710, 710 L plus, 714, 716, 706 air, 710 air, 714 air, 716 air**

1. Im Falle eines Papierstaus läuft das Schneidwerk für 0,5 Sekunden rückwärts.
2. Entnehmen Sie das Papier. Betätigen Sie anschließend zum Freiwerden des Schneidwerks den Vorwärtsschalter.  
Der Rückwärtsschalter ist solange gesperrt bis der Vorwärtsschalter betätigt wurde.
3. Verringern Sie die Blattanzahl.

Je nach Modellvariante enthält Ihr Aktenvernichter nicht alle möglichen Komponenten und Funktionen.

## Energiesparmodus

? 4.



Der Aktenvernichter schaltet bei Nichtbenutzung nach ca. 30 Minuten aus (LED aus).  
Bei Benutzung ist der Aktenvernichter an der Ein-, Aus-, Stop-Taste wieder einzuschalten.



Verwenden Sie ausschließlich nur DAHLE-Ersatzteile!

## Ölen (Partikelschnitt P5)

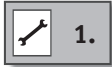

Ölen Sie das Schneidwerk bei nachlassender Schnittleistung, nach jeder Leerung des Auffangbehälters oder spätestens nach Ablauf der auf dem Warnhinweis vermerkten Betriebszeit (**nur bei Partikelschnitt P5**).

1. Schalten Sie den Aktenvernichter an der Ein-, Aus-, Stop-Taste aus.  
Ölen Sie die Schneidwalzen manuell, (DAHLE-Aktenvernichter-Öl verwenden!).
2. Schalten Sie den Aktenvernichter an der Ein-, Aus-, Stop-Taste ein, Schneidwerk ohne Papierzufuhr 10 Sekunden rückwärts laufen lassen.

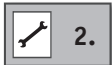

1. Schalten Sie den Aktenvernichter aus und trennen Sie die Netzanschlussleitung von der Netzsteckdose.
2. Reinigen Sie das Gerät nur mit einem trockenen Tuch.
3. Verbinden Sie die Netzanschlussleitung mit der Netzsteckdose, schalten Sie den Aktenvernichter ein.





**Read the operating and safety instructions carefully before putting the document shredder into operation! You must follow the instructions!  
Keep them safe for later use.**

- Only store, transport and operate the document shredder in an **upright position!**
- All liquids and gases used on the document shredder must comply with DAHLE guidelines!
- The document shredder must only be operated in enclosed spaces at temperatures of 15 °C to 32 °C (59 °F–90 °F) and non-condensed humidity of 15% to 95%!
- Do not place the document shredder near a heat source!
- Ensure the document shredder is standing firmly on the floor at a distance of 100 mm from the wall; activate brakes and fasten using the mounting kit if supplied!
- Avoid any accumulation of heat!
- The mains socket must be earthed and easily accessible at all times!
- Use only the mains cable supplied with the device by DAHLE and ensure that it is not damaged!
- Ensure that the building installation has short-circuit protection: max. 16 A (US max. 20 A)!
- Do not use near flammable liquids and gases!
- Do not use near caustic substances!
- Do not subject to moisture!
- Do not open up the machine!
- Automatic start-up!
- Do not operate the document shredder without inserting documents!
- Switch off the shredder at the main switch when it is not in use!
- Only use the document shredder provided that it is in perfect working order, while observing the operating instructions and the usual regulations, guidelines and applicable safety and accident prevention requirements. Take the document shredder out of service immediately if faults occur!
- The device is not intended for use by persons (including children) with restricted physical, sensory or mental capabilities or a lack of experience and knowledge, unless they are working under supervision or receive detailed instruction about how to use the device from a person who is responsible for safety.

NOTE: This equipment has been tested and found to comply with the limits for a Class B digital device, pursuant to part 15 of the FCC Rules. These limits are designed to provide reasonable protection against harmful interference in a residential installation. This equipment generates, uses and can radiate radio frequency energy and, if not installed and used in accordance with the instructions, may cause harmful interference to radio communications. However, there is no guarantee that interference will not occur in a particular installation. If this equipment does cause harmful interference to radio or television reception, which can be determined by turning the equipment off and on, the user is encouraged to try to correct the interference by one or more of the following measures:

- Reorient or relocate the receiving antenna.
- Increase the separation between the equipment and receiver.
- Connect the equipment into an outlet on a circuit different from that to which the receiver is connected.
- Consult the dealer or an experienced radio/TV technician for help.

**WARNING:** Changes or modifications to this unit, expressly approved by the party responsible for compliance, could void the user's authority to operate the equipment!



- 1 - It is obligatory to follow the safety instructions!
- 2 - **Read the operating and safety instructions carefully before putting the document shredder into operation!**
- 3 - This document shredder is not intended to be used by children (the product is not a toy)!
- 4 - Do not touch the paper feed with your hands!
- 5 - Do not allow items of clothing to touch the paper feed!
- 6 - Do not allow your hair to touch the paper feed!
- 7 - Prior to maintenance work, disconnect the document shredder from the electrical power supply!
- 8 - Wear protective goggles when shredding CDs or DVDs!
- 9 - Remove paper clips and staples before shredding! (security level P6 and P7 devices)

## Pay attention to warnings!



- 1 - Noise level when operated without shredding documents (in accordance with DIN)
- 2 - Document shredder on stand-by
- 3 - Document shredder in operation
- 4 - Automatic start-up
- 5 - Oil (only use DAHLE oil!)
- 6 - Dispose of the document shredder appropriately and in an environmentally friendly manner at an authorised collection point.  
Do not dispose of any parts of the document shredder or packaging in domestic waste.

## Intended use, warranty

The document shredder is intended to be used for shredding paper. Depending on the model variant, a small amount of the following materials can also be shredded:

- CDs/DVDs, bank cards and credit cards (see technical data)
- The normal staples and paper clips found in paper documents  
(exception: security level P6 and P7 devices)

Wear, damage due to improper use or unauthorised modifications and repairs are not covered by the warranty or the guarantee.

The document shredder was designed for private use and for use in normal office environments.





The following conditions apply to the performance in terms of sheets listed under technical data: Maximum number of sheets that are shredded in one pass under the following conditions: New cutting rollers, oiled if needed, cold motor, power supply with nominal voltage and nominal frequency (230 V/ 50 Hz; 120 V/60 Hz). Deviations may result in reduced sheet processing and increased operating noises. The sheets are fed centrally and lengthwise at a 90 degree angle. The performance in terms of sheets can also vary depending on the paper properties and input.

**Subject to technical modifications!**

**Remove transport lock!**

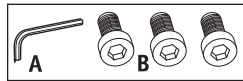
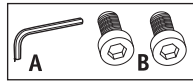
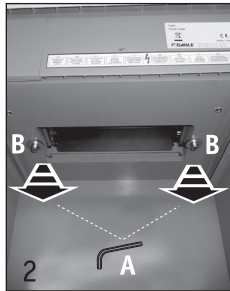

1. Apply the brakes! Prior to putting into operation for the first time, open the door and remove the paper collection bin.
2. Remove the screws for the transport lock (paper collection bin compartment) from the base plate underneath the shredding mechanism, re-fit paper collection bin and close door.
3. Each time the appliance is moved, the transport lock must be re-fitted.

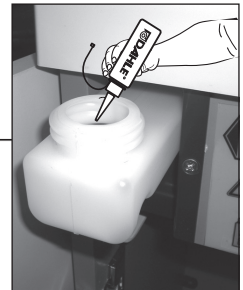
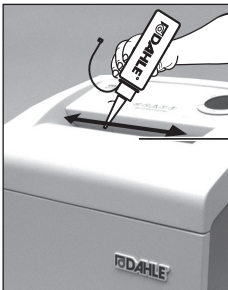

1. Oil the shredding rollers using DAHLE document shredder oil (P5, P6 and P7 cross-cut shredding only)!
2. Fill the oil tank with DAHLE document shredder oil!



Depending on the model variant, your document shredder may not have all the possible components and functions.

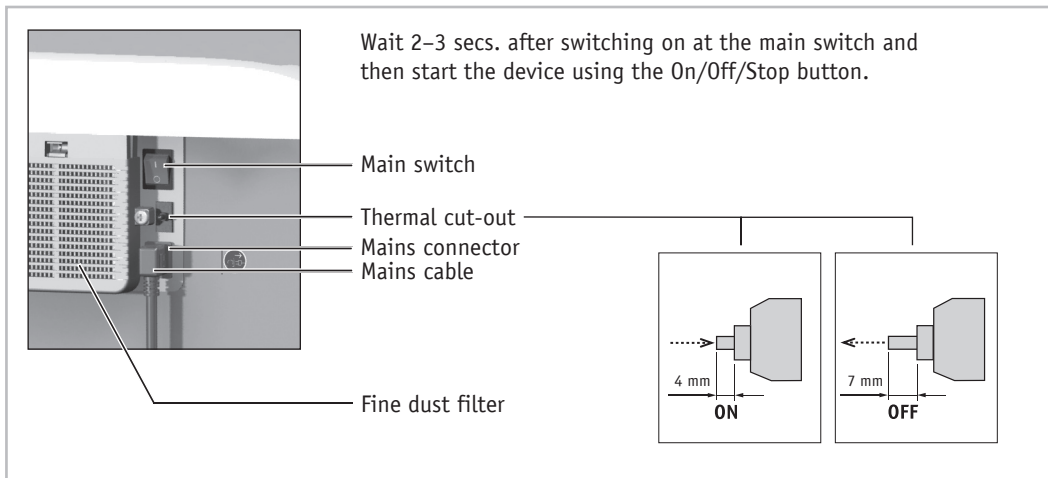
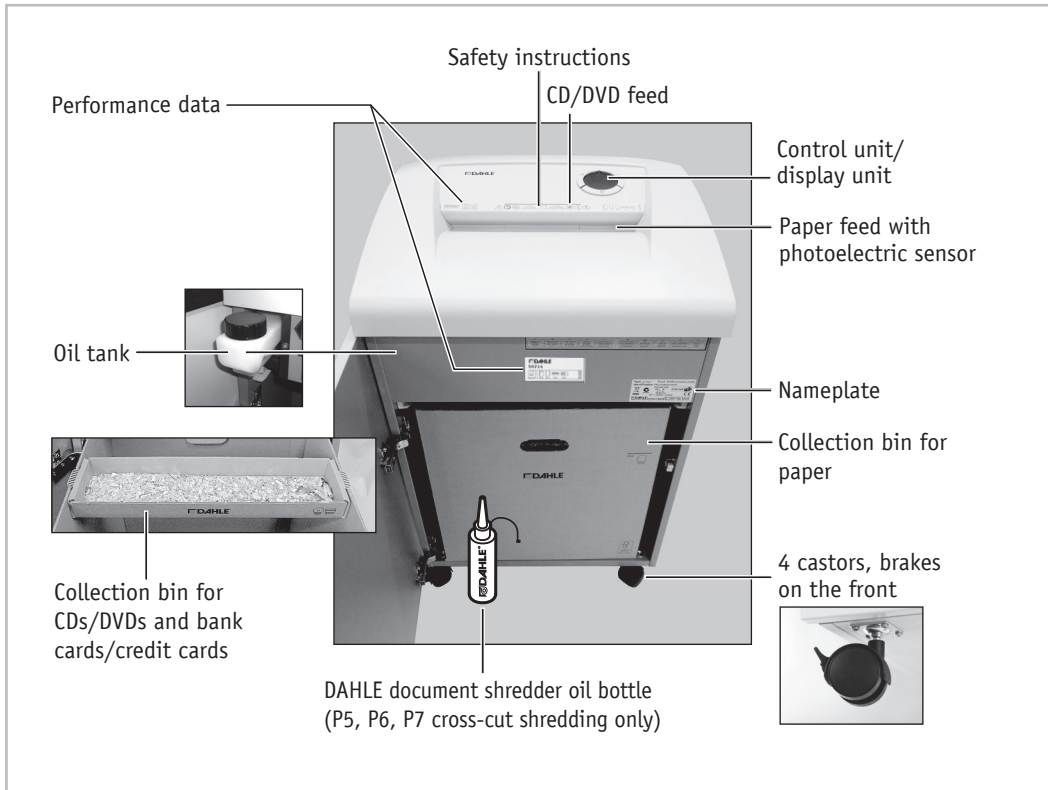



Depending on the model variant, your document shredder may not have all the possible components and functions.

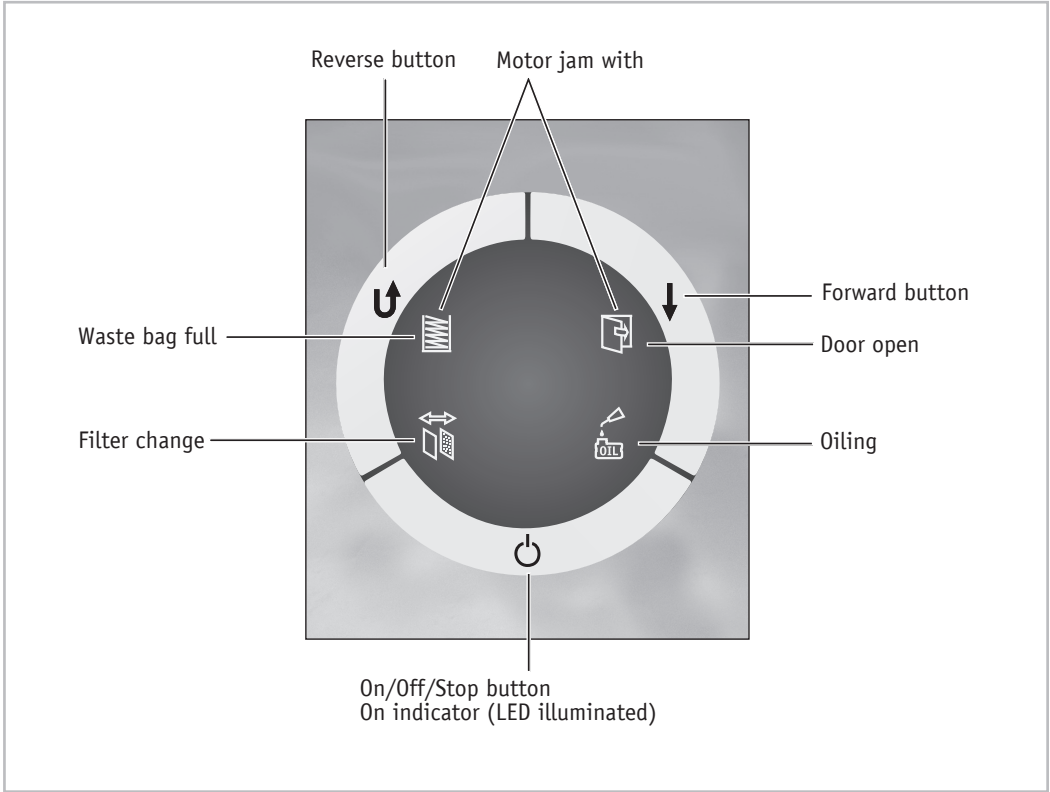

Type  
Prod. Code





XXX-XXX V  
XX Hz

1. Check that the voltage and mains frequency of your electricity supply match the information on the nameplate.











							Security levels according to DIN 66399*				
							P	F	0	T	E
			DIN A4- 70g/m <sup>2</sup>	DIN A4- 80g/m <sup>2</sup>							
104	40206	240	19	16	5.8mm	-	P-2	-	0-2	T-2	E-2
106	40306	260	27	22	5.8mm	-	P-2	-	0-2	T-2	E-2
110	40406	260	29	23	5.8mm	-	P-2	-	0-2	T-2	E-2
114	40506	310	43	35	5.8mm	-	P-2	-	0-2	T-2	E-2
116	40606	400	45	36	5.8mm	-	P-2	-	0-2	T-2	E-2
104 air	41206	240	19	16	5.8mm	-	P-2	-	0-2	T-2	E-2
106 air	41306	260	27	22	5.8mm	-	P-2	-	0-2	T-2	E-2
110 air	41406	260	29	23	5.8mm	-	P-2	-	0-2	T-2	E-2
114 air	41506	310	43	35	5.8mm	-	P-2	-	0-2	T-2	E-2
116 air	41606	400	45	36	5.8mm	-	P-2	-	0-2	T-2	E-2
203	40104	220	15	13	3.9mm	-	P-2	-	-	T-2	E-2
204	40204	240	17	14	3.9mm	-	P-2	-	-	T-2	E-2
206	40304	260	23	18	3.9mm	-	P-2	-	0-2	T-2	E-2
210	40404	260	24	19	3.9mm	-	P-2	-	0-2	T-2	E-2
214	40504	310	33	26	3.9mm	-	P-2	-	0-2	T-2	E-2
216	40604	400	35	28	3.9mm	-	P-2	-	0-2	T-2	E-2
204 air	41204	240	17	14	3.9mm	-	P-2	-	-	T-2	E-2
206 air	41304	260	23	18	3.9mm	-	P-2	-	0-2	T-2	E-2
210 air	41404	260	24	19	3.9mm	-	P-2	-	0-2	T-2	E-2
214 air	41504	310	33	26	3.9mm	-	P-2	-	0-2	T-2	E-2
216 air	41604	400	35	28	3.9mm	-	P-2	-	0-2	T-2	E-2
306	50310	260	19-21	18-20	-	5.0x50mm	P-3	-	0-3	T-3	E-2
310	50410	260	19-21	18-20	-	5.0x50mm	P-3	-	0-3	T-3	E-2
306 air	51310	260	19-21	18-20	-	5.0x50mm	P-3	-	0-3	T-3	E-2
310 air	51410	260	19-21	18-20	-	5.0x50mm	P-3	-	0-3	T-3	E-2
403	50114	240	8-10	7-9	-	4.0x40.0mm	P-4	F-1	-	T-4	E-3
404	50214	240	8-10	7-9	-	4.0x40.0mm	P-4	F-1	-	T-4	E-3
406	50314	260	17-19	15-17	-	4.0x40.0mm	P-4	F-1	0-3	T-4	E-3
410	50414	260	17-19	15-17	-	4.0x40.0mm	P-4	F-1	0-3	T-4	E-3
410 L plus	50464	310	25-27	24-26	-	4.0x40.0mm	P-4	F-1	0-3	T-4	E-3
414	50514	310	25-27	24-26	-	4.0x40.0mm	P-4	F-1	0-3	T-4	E-3
416	50564	400	19-21	18-20	-	4.0x40.0mm	P-4	F-1	0-3	T-4	E-3
404 air	51214	240	8-10	7-9	-	4.0x40.0mm	P-4	F-1	-	T-4	E-3
406 air	51314	260	17-19	15-17	-	4.0x40.0mm	P-4	F-1	0-3	T-4	E-3
410 air	51414	260	17-19	15-17	-	4.0x40.0mm	P-4	F-1	0-3	T-4	E-3
410 L plus air	51464	310	25-27	24-26	-	4.0x40.0mm	P-4	F-1	0-3	T-4	E-3





































		220-240V 50-60Hz	100-120V 50-60Hz				
	Speed m/min				Dimensions H x W x D mm	Capacity l	Weight kg
<=47dB/A	6.0	350W	400W	-	705x430x350	40	25.0
<=47dB/A	4.0	650W	680W	-	865x545x435	60	43.0
<=51dB/A	4.4	650W	680W	-	944x545x435	100	45.0
<=46dB/A	4.5	900W	900W	-	890x734x511	140	64.0
<=50dB/A	6.0	1650W	1650W	-	960x734x511	160	92.0
<=47dB/A	6.0	350W	400W	-	705x430x350	40	26.0
<=47dB/A	4.0	650W	680W	-	865x545x435	60	44.0
<=51dB/A	4.4	650W	680W	-	944x545x435	100	46.0
<=46dB/A	4.5	900W	900W	-	890x734x511	140	65.0
<=50dB/A	6.0	1650W	1650W	-	960x734x511	160	93.0
<=49dB/A	6.0	350W	400W	-	628x430x350	30	22.5
<=46dB/A	6.0	350W	400W	-	705x430x350	40	25.0
<=46dB/A	4.0	650W	680W	-	865x545x435	60	43.0
<=51dB/A	4.4	650W	680W	-	944x545x435	100	45.0
<=47dB/A	4.5	900W	900W	-	890x734x511	140	64.0
<=49dB/A	6.0	1650W	1650W	-	960x734x511	160	92.0
<=46dB/A	6.0	350W	400W	-	705x430x350	40	26.0
<=46dB/A	4.0	650W	680W	-	865x545x435	60	44.0
<=51dB/A	4.4	650W	680W	-	944x545x435	100	46.0
<=47dB/A	4.5	900W	900W	-	890x734x511	140	65.0
<=49dB/A	6.0	1650W	1650W	-	960x734x511	160	93.0
<=46dB/A	4.5	650W	680W	-	865x545x435	60	43.0
<=46dB/A	4.5	650W	680W	-	944x545x435	100	45.0
<=46dB/A	4.5	650W	680W	-	865x545x435	60	43.5
<=46dB/A	4.5	650W	680W	-	944x545x435	100	45.5
<=44dB/A	6.5	350W	400W	-	628x430x350	30	23.0
<=46dB/A	6.5	350W	400W	-	705x430x350	40	25.0
<=46dB/A	4.5	650W	680W	-	865x545x435	60	43.0
<=52dB/A	4.5	650W	680W	-	944x545x435	100	45.0
<=52dB/A	4.7	900W	900W	-	944x545x435	100	54.5
<=52dB/A	4.7	900W	900W	-	890x734x511	140	64.0
<=52dB/A	5.7	900W	900W	-	960x734x511	160	68.5
<=46dB/A	6.5	350W	400W	-	705x430x350	40	25.5
<=46dB/A	4.5	650W	680W	-	865x545x435	60	43.5
<=52dB/A	4.5	650W	680W	-	944x545x435	100	45.5
<=52dB/A	4.7	900W	900W	-	944x545x435	100	55.0



		Security levels according to DIN 66399*									
							P	F	0	T	E
			DIN A4-70g/m <sup>2</sup>	DIN A4-80g/m <sup>2</sup>							
414 air	51514	310	25-27	24-26	-	4.0x40.0mm	P-4	F-1	0-3	T-4	E-3
416 air	51564	400	19-21	18-20	-	4.0x40.0mm	P-4	F-1	0-3	T-4	E-3
504	40222	240	6	5	-	2.0x15.0mm	P-5	F-2	-	T-5	E-4
506	50322	260	12-14	11-13	-	2.0x15.0mm	P-5	F-2	-	T-5	E-4
510	50422	260	12-14	11-13	-	2.0x15.0mm	P-5	F-2	-	T-5	E-4
510 L plus	50472	310	18-20	17-19	-	2.0x15.0mm	P-5	F-2	0-4	T-5	E-4
514	50522	310	18-20	17-19	-	2.0x15.0mm	P-5	F-2	0-4	T-5	E-4
516	50572	400	14-16	13-15	-	2.0x15.0mm	P-5	F-2	0-4	T-5	E-4
504 air	41222	240	6	5	-	2.0x15.0mm	P-5	F-2	-	T-5	E-4
506 air	51322	260	12-14	11-13	-	2.0x15.0mm	P-5	F-2	-	T-5	E-4
510 air	51422	260	12-14	11-13	-	2.0x15.0mm	P-5	F-2	-	T-5	E-4
510 L plus air	51472	310	18-20	17-19	-	2.0x15.0mm	P-5	F-2	0-4	T-5	E-4
514 air	51522	310	18-20	17-19	-	2.0x15.0mm	P-5	F-2	0-4	T-5	E-4
516 air	51572	400	14-16	13-15	-	2.0x15.0mm	P-5	F-2	0-4	T-5	E-4
604	40230	240	3	2	-	0.8x12.0mm	P-6	F-3	-	-	-
606	40330	260	6	5	-	0.8x12.0mm	P-6	F-3	-	T-6	-
610	40430	260	7	6	-	0.8x12.0mm	P-6	F-3	-	T-6	-
614	40530	310	11	9	-	0.8x12.0mm	P-6	F-3	-	T-6	-
616	40630	400	14	11	-	0.8x12.0mm	P-6	F-3	-	T-6	-
604 air	41230	240	3	2	-	0.8x12.0mm	P-6	F-3	-	-	-
606 air	41330	260	6	5	-	0.8x12.0mm	P-6	F-3	-	T-6	-
610 air	41430	260	7	6	-	0.8x12.0mm	P-6	F-3	-	T-6	-
614 air	41530	310	11	9	-	0.8x12.0mm	P-6	F-3	-	T-6	-
616 air	41630	400	14	11	-	0.8x12.0mm	P-6	F-3	-	T-6	-
706	40334	260	6	5	-	1.0x4.7mm	P-7	F-3	-	T-6	-
710	40434	260	6	5	-	1.0x4.7mm	P-7	F-3	-	T-6	-
710 L plus	40484	310	9	7	-	1.0x4.7mm	P-7	F-3	-	T-6	-
714	40534	310	9	7	-	1.0x4.7mm	P-7	F-3	-	T-6	-
716	40634	400	12	9	-	1.0x4.7mm	P-7	F-3	-	T-6	-
706 air	41334	260	6	5	-	1.0x4.7mm	P-7	F-3	-	T-6	-
710 air	41434	260	6	5	-	1.0x4.7mm	P-7	F-3	-	T-6	-
714 air	41534	310	9	7	-	1.0x4.7mm	P-7	F-3	-	T-6	-
716 air	41634	400	12	9	-	1.0x4.7mm	P-7	F-3	-	T-6	-



		220-240V 50-60Hz	100-120V 50-60Hz				
	Speed m/min				Dimensions H x W x D mm	Capacity l	Weight kg
<=52dB/A	4.7	900W	900W	-	890x734x511	140	64.5
<=52dB/A	5.7	900W	900W	-	960x734x511	160	69.0
<=47dB/A	6.0	350W	400W		705x430x350	40	25.0
<=46dB/A	4.4	650W	680W		865x545x435	60	44.0
<=53dB/A	4.4	650W	680W		944x545x435	100	46.0
<=53dB/A	4.8	900W	900W		944x545x435	100	59.0
<=52dB/A	4.8	900W	900W		890x734x511	140	68.5
<=53dB/A	5.6	900W	900W		960x734x511	160	75.0
<=47dB/A	6.0	350W	400W		705x430x350	40	26.0
<=46dB/A	4.4	650W	680W		865x545x435	60	43.0
<=53dB/A	4.4	650W	680W		944x545x435	100	47.0
<=53dB/A	4.8	900W	900W		944x545x435	100	60.0
<=53dB/A	4.8	900W	900W		890x734x511	140	69.5
<=53dB/A	5.6	900W	900W		960x734x511	160	76.0
<=50dB/A	6.0	350W	400W		705x430x350	40	25.0
<=47dB/A	3.5	650W	680W		865x545x435	60	43.0
<=52dB/A	4.3	650W	680W		944x545x435	100	45.0
<=50dB/A	4.5	900W	900W		890x734x511	140	64.0
<=50dB/A	4.0	1650W	1650W		960x734x511	160	92.0
<=50dB/A	6.0	350W	400W		705x430x350	40	26.0
<=47dB/A	3.5	650W	680W		865x545x435	60	44.0
<=52dB/A	4.3	650W	680W		944x545x435	100	46.0
<=50dB/A	4.5	900W	900W		890x734x511	140	65.0
<=50dB/A	4.0	1650W	1650W		960x734x511	160	93.0
<=50dB/A	6.5	650W	680W		865x545x435	60	43.0
<=52dB/A	6.5	650W	680W		944x545x435	100	45.0
<=52dB/A	7.0	900W	900W		944x545x435	100	60.0
<=52dB/A	7.0	900W	900W		890x734x511	140	64.0
<=52dB/A	8.0	1650W	1650W		960x734x511	160	92.0
<=50dB/A	6.5	650W	680W		865x545x435	60	44.0
<=52dB/A	6.5	650W	680W		944x545x435	100	46.0
<=52dB/A	7.0	900W	900W		890x734x511	140	65.0
<=52dB/A	8.0	1650W	1650W		960x734x511	160	93.0



1.

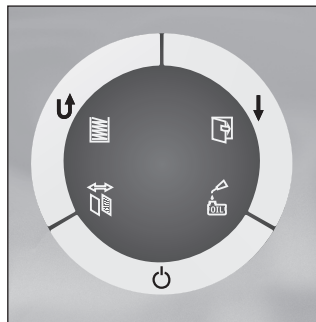

**Please follow the safety instructions.**

1. Prior to using the document shredder, please check the position of the collection bin for CDs/DVDs and bank cards/credit cards. When shredding paper, this bin must be at the front of the collection bin for paper.
2. Close the door of the document shredder.
3. Connect the mains cable supplied to the document shredder and plug into a mains socket. Switch on the main switch. After switching on at the main switch, wait 2–3 seconds.
4. Switch on the document shredder with the On/Off/Stop button.

1.1

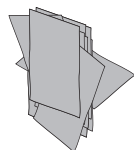

O.K.



1. **Observe the maximum number of sheets of paper as stated in the technical data!**
2. Insert the paper into the middle of the paper feed: the built-in photoelectric sensor starts the document shredder automatically.
3. Once the paper feed is clear again, the document shredder switches off automatically and goes into stand-by.
4. **Continuous operation** - If you hold down the Forward button (for approx. 5 sec.), the document shredder changes to continuous operation.
5. If the supply of paper is interrupted for 15 seconds, continuous operation is interrupted.





Depending on the model variant, your document shredder may not have all the possible components and functions.

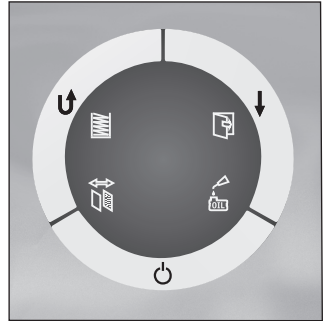
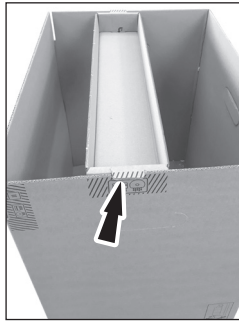
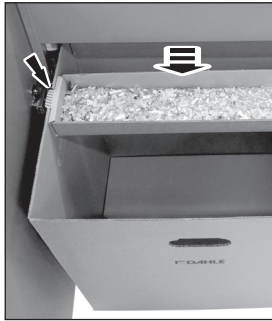

**Please follow the safety instructions: Wear protective goggles when shredding CDs or DVDs!**

1. Prior to using the document shredder, please check the position of the collection bin for CDs/DVDs and bank cards/credit cards. **When shredding CDs/DVDs and bank cards/credit cards**, this bin must be **at the rear** of the collection bin for paper.
2. Pull out collection bin and position the collection bin for CDs/DVDs and credit cards/bank cards at the rear.
3. Close the door of the document shredder.
4. Switch on the document shredder with the On/Off/Stop button.



1. Insert the CDs, DVDs or bank cards/credit cards in the middle of the feed while keeping the Forward button pressed.
2. Once the CD/DVD feed is clear again, the document shredder switches off automatically and goes into stand-by.



Depending on the model variant, your document shredder may not have all the possible components and functions.

## DAHLE CleanTEC® Change DAHLE fine dust filter

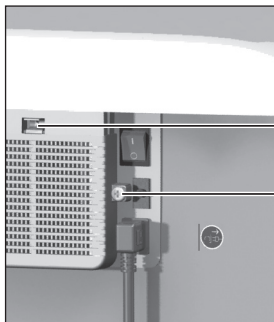
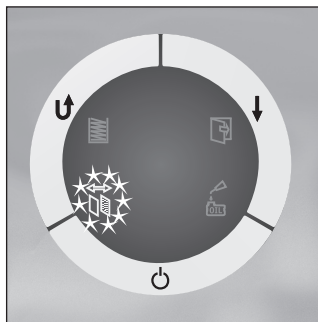

Catch

Screw

1. The filter change indicator (**change DAHLE fine dust filter!**) is illuminated on the control panel.
2. Unplug the mains cable from the mains socket.
3. Change the fine dust filter on the rear of the appliance.
  - A. Undo screw.
  - B. Press catch and remove cover.
  - C. Remove filter and dispose of it. The replacement filter that you fit must be a **DAHLE fine dust filter!**
  - D. Close cover.
  - E. Tighten screw.
4. Plug the mains cable into the mains socket and switch on at the main switch and the On/Off/Stop button.
5. Reset filter change indicator: Keep the Forward and Reverse buttons pressed simultaneously for approx. 5 seconds.

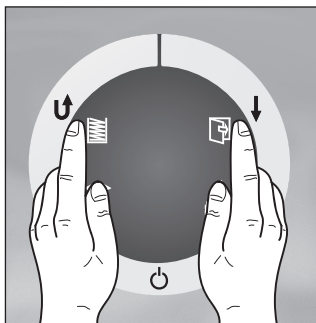

**We do not accept any liability for improper use of the DAHLE fine dust filter or for not changing the DAHLE fine dust filter. The used DAHLE fine dust filter can be disposed in the domestic waste.**

**The fine dust particles are bound into the DAHLE fine dust filter. Please dispose of the DAHLE fine dust filter in a manner so that it is inaccessible for children.**



Depending on the model variant, your document shredder may not have all the possible components and functions.

## Automatic oiling (only P5, P6 and P7 cross-cut shredding)

Fill oil tank with DAHLE document shredder oil.

Integrated oil tank for regulated, automatic oiling of the rollers.

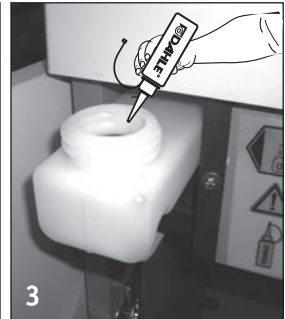
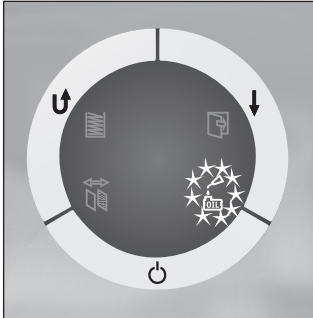

Fill the integrated oil tank in the document shredder when indicated on the display.

1. Switch off the document shredder with the On/Off/Stop button.
2. Open the door. The integrated oil tank is in the cabinet. Open the cap.
3. Fill **oil tank with oil** (use DAHLE document shredder oil!) and close again.



## Meaning of the signals

Depending on the model variant, your document shredder may not have all the possible components and functions.

**Collection bin full** – The LED is flashing.

! 3.

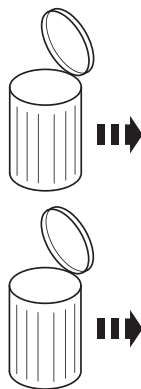
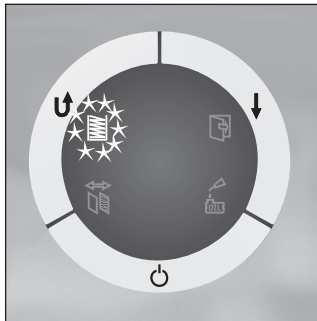

1. 1. If the collection bin is full, the shredding process is stopped; this situation is indicated optically.
2. 2. Switch off the main switch and unplug the mains cable from the mains socket.
3. 3. Remove collection bin, empty and re-fit.
4. 4. Plug the mains cable into the mains socket and switch on the main switch.



Depending on the model variant, your document shredder may not have all the possible components and functions.

**Automatic motor shut-down** – The LEDs for the fill level and door are flashing.

4.

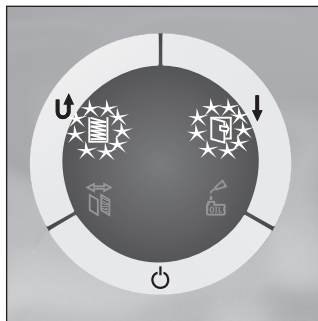

1. Automatic motor shut down in case of:
  - Overheating of the motor
  - Paper jam

**Door open** – The LED is flashing.

5.

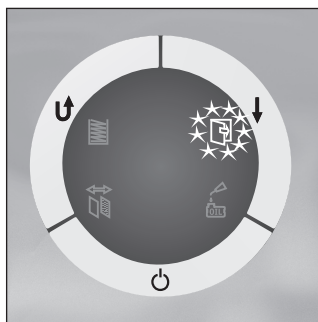

1. If the door is open, the shredding process is stopped and LED is flashing: close the door.



Depending on the model variant, your document shredder may not have all the possible components and functions.

? 1.

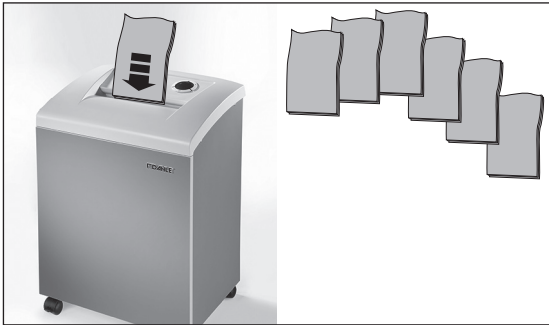

The document shredder switches off automatically after extended operation and/or overload to cool down.

? 2.



Thermal cut-out

### The shredding process is not started:

- Mains cable not plugged into the mains socket
- Main switch not on?
- On/Off/Stop button not switched on?
- Door open
- Collection bin full
- Device overloaded/overheated?
- Thermal cut-out OFF?

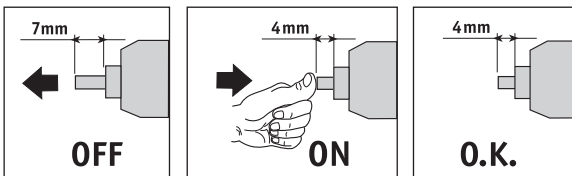

Set the thermal cut-out to the correct position – ON.

Depending on the model variant, your document shredder may not have all the possible components and functions.

? 3.

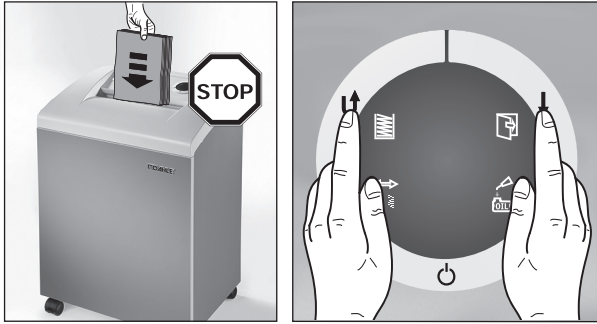

1. If there are too many sheets of paper, the shredding process is stopped.
2. The shredding mechanism automatically runs in reverse for a short time and the paper is ejected.
3. **ATTENTION! To avoid damaging the shredding mechanism, do not operate the Forward and Reverse switches alternately!**

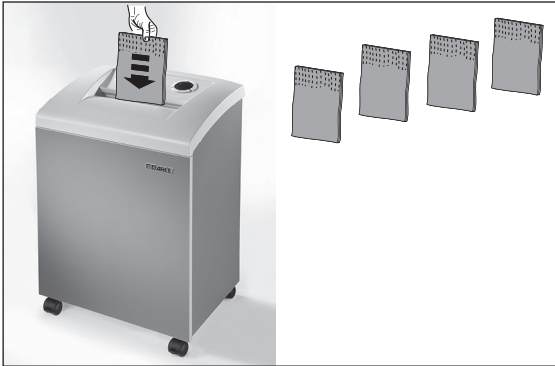

4. If paper continues to be jammed, operate the Reverse button briefly.
5. Reduce the number of sheets of paper by removing or tearing off.
6. The shredding process starts automatically after the paper is inserted again, otherwise operate the Forward button.

**706, 710, 710 L plus, 714, 716, 706 air, 710 air, 714 air, 716 air**

40334, 40434, 40484, 40534, 40634, 41334, 41434, 41534, 41634

1. In the event of a paper jam, the shredding mechanism runs in reverse for 0.5 seconds.
2. Remove the paper. Then operate the Forward switch to clear the shredding mechanism. The Reverse switch is inhibited until the Forward switch has been actuated.
3. Reduce the number of sheets of paper.



Depending on the model variant, your document shredder may not have all the possible components and functions.

## Energy-saving mode

? 4.



If not used, the document shredder switches off after approx. 30 minutes (LED off).  
To use the document shredder, switch it back on with the On/Off/Stop button.





Use only DAHLE spare parts!

## Oiling (P5 cross-cut shredding)

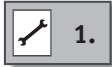

If the shredding performance drops, oil the shredding mechanism after each time you empty the collection bin or at least after the operating time stated in the warning notice has elapsed **(for P5 cross-cut shredding only)**.

1. Switch off the document shredder with the On/Off/Stop button. Oil the shredding rollers manually (use DAHLE document shredder oil!).
2. Switch on the document shredder with the On/Off/Stop button and run the shredding mechanism in reverse for 10 seconds without paper feed.

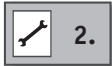

1. Switch off the document shredder and unplug the mains cable from the mains socket.
2. Clean the appliance using only a dry cloth.
3. Plug the mains cable into the mains socket and switch on the document shredder.



**Lisez attentivement le mode d'emploi et les consignes de sécurité avant de mettre en marche le destructeur de documents ! Les consignes doivent être appliquées ! Conservez ces documents pour une utilisation ultérieure.**

- Le destructeur de documents doit toujours être rangé ou transporté **en position verticale !**
- Utiliser à proximité du destructeur de documents uniquement des liquides et des gaz conformes aux directives DAHLE !
- Le destructeur de documents est destiné à être utilisé dans des locaux fermés à des températures comprises entre 15 °C et 32 °C (59 °F - 90 °F) et une hygrométrie non condensée comprise entre 15 % et 95 % !
- Le destructeur de documents ne doit pas être installé à proximité d'une source de chaleur !
- Placer le destructeur de documents au sol de manière à ce qu'il soit bien stable et à une distance de 100 mm du mur, actionner les freins de blocage et fixer l'appareil, le cas échéant, avec le kit de montage fourni !
- Éviter la chaleur stagnante !
- La prise de courant raccordée à la terre doit toujours être aisément accessible !
- Utiliser uniquement un câble électrique intact fourni par la société DAHLE !
- L'installation électrique du bâtiment doit être protégée contre les courts-circuits 16 A max. (20 A max. aux USA) !
- Ne pas utiliser l'appareil à proximité de liquides et gaz inflammables !
- Ne pas utiliser l'appareil à proximité de substances corrosives !
- Ne pas exposer l'appareil à l'humidité !
- Il est interdit d'ouvrir l'appareil !
- Démarrage automatique !
- Ne pas laisser le destructeur de documents tourner à vide !
- En cas de non utilisation, arrêter le destructeur de documents au niveau de l'interrupteur principal !
- Utiliser le destructeur de documents uniquement s'il est en parfait état de fonctionnement et tenir compte pour cela du mode d'emploi, des directives et dispositions usuelles ainsi que des règles de sécurité et normes de prévention des accidents en vigueur. En cas de dysfonctionnement, mettre le destructeur de documents immédiatement hors service !
- L'appareil n'est pas destiné à être exploité par des personnes (y compris les enfants) aux capacités physiques, sensorielles ou mentales restreintes ou manquant d'expérience et de connaissances, à moins qu'elles opèrent sous surveillance ou reçoivent des instructions complètes sur l'utilisation de l'appareil par une personne responsable de la sécurité.



- 1 - Les consignes de sécurité doivent être appliquées !
- 2 - **Lisez attentivement le mode d'emploi et les consignes de sécurité avant de mettre en marche le destructeur de documents !**
- 3 - Ce destructeur de documents n'est pas destiné à être utilisé par des enfants (le produit n'est pas un jouet) !
- 4 - Ne touchez pas le dispositif d'alimentation du papier avec les mains !
- 5 - Ne touchez pas le dispositif d'alimentation du papier avec des vêtements !
- 6 - Ne touchez pas le dispositif d'alimentation du papier avec les cheveux !
- 7 - Débrancher le destructeur de documents de la source d'électricité avant de procéder aux opérations d'entretien !
- 8 - Pour détruire des CD et DVD, porter des lunettes de protection !
- 9 - Retirer les trombones et les agrafes des documents avant de les détruire !  
(appareils de niveau de sécurité P6 et P7)



## Respecter les mises en garde !



- <sup>1</sup> - Volume sonore à vide (selon la norme DIN)
- <sup>2</sup> - Destructeur de documents en veille
- <sup>3</sup> - Destructeur de documents en marche
- <sup>4</sup> - Démarrage automatique
- <sup>5</sup> - Lubrifier l'appareil (utilisez uniquement des huiles DAHLE !)
- <sup>6</sup> - Respectez les instructions appropriées pour une élimination du destructeur de documents qui respecte l'environnement. Apportez-le dans un point de collecte autorisé.  
Ne jetez pas de composants de l'appareil ou de l'emballage avec les ordures ménagères

## Utilisation conforme, garantie

Le destructeur de documents est destiné à détruire des documents papier. Selon le modèle, vous pouvez en outre utiliser l'appareil pour détruire les matériaux suivants en petite quantité :

- CD/DVD, cartes bancaires et de crédit (voir Caractéristiques techniques)
- les agrafes et trombones présents dans les documents en papier, en quantités représentant une utilisation normale (exception : appareils de niveau de sécurité P6 et P7)

L'usure, les dommages dus à une utilisation incorrecte et les interventions de tierces personnes ne sont pas couvertes par la responsabilité du fabricant ni par la garantie.

Le destructeur de documents est conçu pour l'utilisation domestique et en environnement de bureau normal.

En ce qui concerne la capacité de feuilles mentionnée dans les caractéristiques techniques, les conditions cadres suivantes sont applicables :

Nombre maximum de feuilles pouvant être découpées en un passage dans les conditions suivantes : Rouleaux de coupe neufs, huilés le cas échéant, moteur froid, alimentation avec tension et fréquence nominales (230 V/50 Hz ; 120 V/60 Hz). Des divergences peuvent entraîner une capacité de feuilles réduite et des émissions sonores accrues. Les feuilles sont introduites au centre et en longueur à un angle inférieur à 90°. La capacité de feuilles peut également varier selon les caractéristiques du papier et l'introduction.

## Sous réserve de modifications techniques !

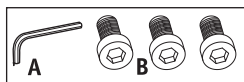
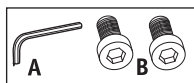
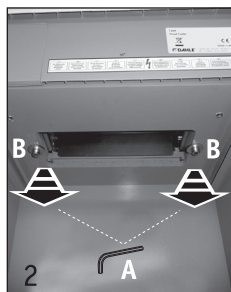
**Retirer le dispositif de sécurité destiné à protéger l'appareil durant le transport !**

1. Actionner les freins de blocage ! Avant la première mise en service, ouvrir la porte et retirer le bac de réception du papier.
2. Retirer les vis de sécurité (zone d'insertion du bac de réception du papier) qui se trouvent sur le socle sous le système de coupe et sont destinées à protéger l'appareil durant le transport, puis remettre en place le bac de réception et refermer la porte.
3. Le dispositif de protection pour le transport doit être remis en place chaque fois que vous changez l'appareil de place.

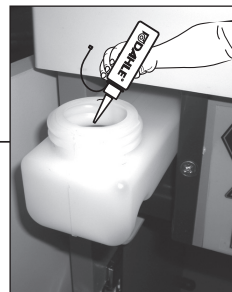

1. Lubrifiez les rouleaux de coupe avec de l'huile pour destructeurs de documents DAHLE (uniquement pour les coupes en particules P5, P6 et P7) !
2. Remplissez la réserve d'huile pour destructeurs de documents DAHLE !



Selon le modèle, votre destructeur de documents ne comporte pas tous les composants et les fonctions indiqués.

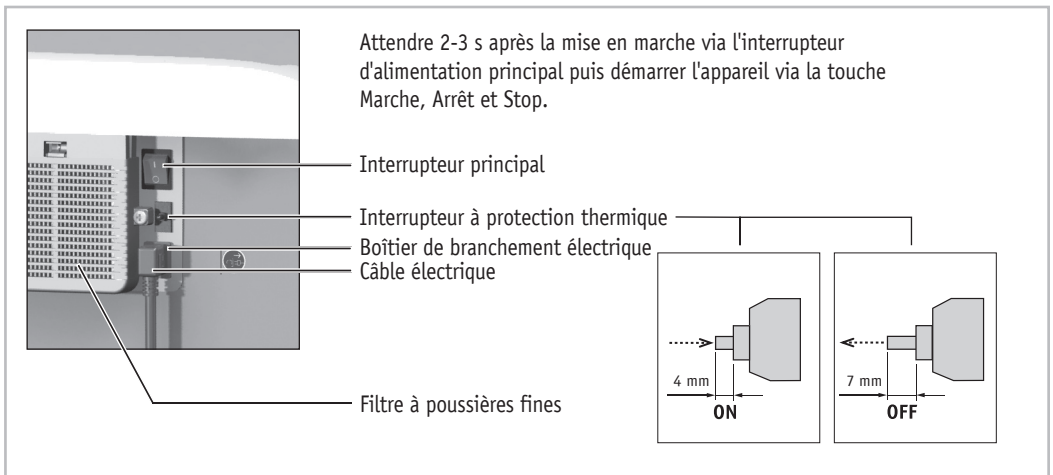
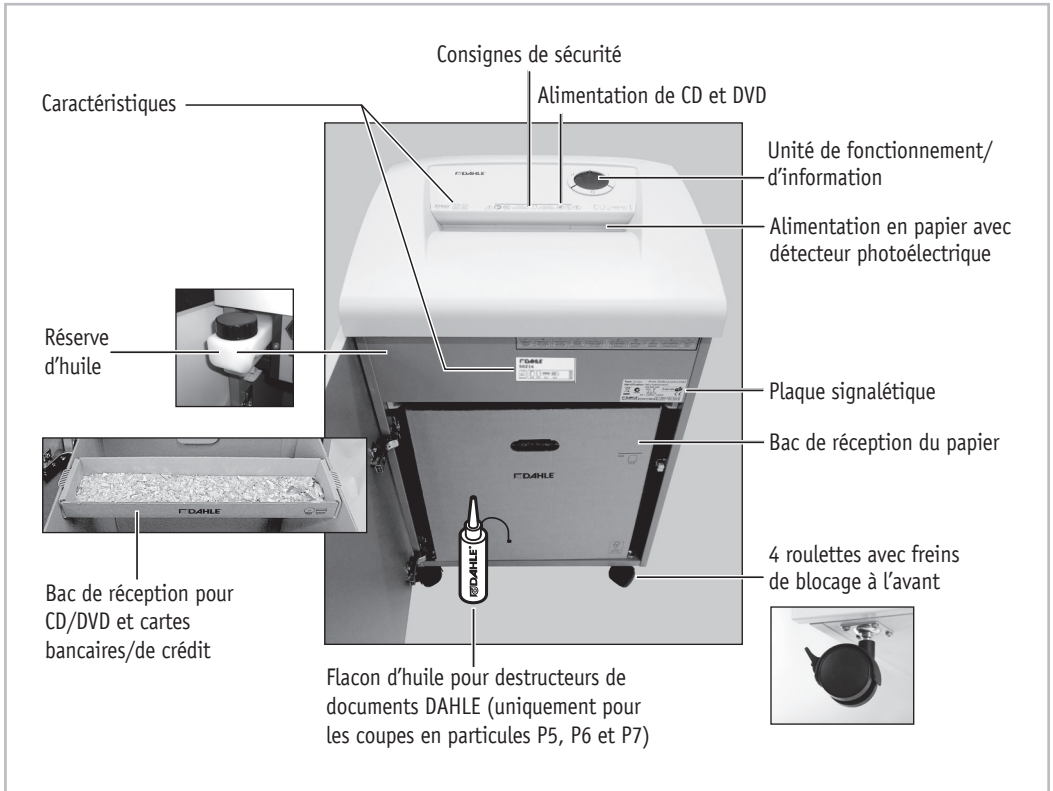



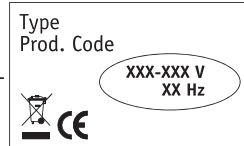
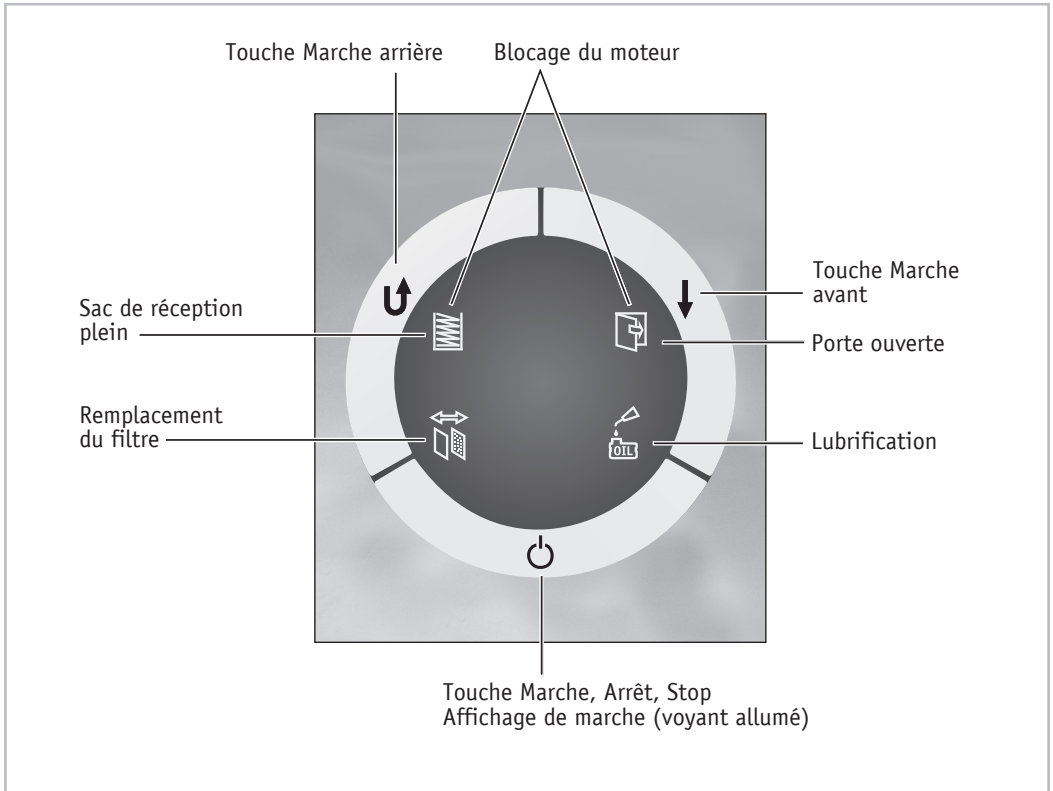





Selon le modèle, votre destructeur de documents ne comporte pas tous les composants et les fonctions indiqués.







1. Vérifiez que la tension et la fréquence de votre réseau électrique correspondent aux indications figurant sur la plaque signalétique.











							Niveaux de sécurité selon la norme DIN 66399*				
							P	F	0	T	E
			DIN A4- 70g/m <sup>2</sup>	DIN A4- 80g/m <sup>2</sup>							
104	40206	240	19	16	5,8mm	-	P-2	-	0-2	T-2	E-2
106	40306	260	27	22	5,8mm	-	P-2	-	0-2	T-2	E-2
110	40406	260	29	23	5,8mm	-	P-2	-	0-2	T-2	E-2
114	40506	310	43	35	5,8mm	-	P-2	-	0-2	T-2	E-2
116	40606	400	45	36	5,8mm	-	P-2	-	0-2	T-2	E-2
104 air	41206	240	19	16	5,8mm	-	P-2	-	0-2	T-2	E-2
106 air	41306	260	27	22	5,8mm	-	P-2	-	0-2	T-2	E-2
110 air	41406	260	29	23	5,8mm	-	P-2	-	0-2	T-2	E-2
114 air	41506	310	43	35	5,8mm	-	P-2	-	0-2	T-2	E-2
116 air	41606	400	45	36	5,8mm	-	P-2	-	0-2	T-2	E-2
203	40104	220	15	13	3,9mm	-	P-2	-	-	T-2	E-2
204	40204	240	17	14	3,9mm	-	P-2	-	-	T-2	E-2
206	40304	260	23	18	3,9mm	-	P-2	-	0-2	T-2	E-2
210	40404	260	24	19	3,9mm	-	P-2	-	0-2	T-2	E-2
214	40504	310	33	26	3,9mm	-	P-2	-	0-2	T-2	E-2
216	40604	400	35	28	3,9mm	-	P-2	-	0-2	T-2	E-2
204 air	41204	240	17	14	3,9mm	-	P-2	-	-	T-2	E-2
206 air	41304	260	23	18	3,9mm	-	P-2	-	0-2	T-2	E-2
210 air	41404	260	24	19	3,9mm	-	P-2	-	0-2	T-2	E-2
214 air	41504	310	33	26	3,9mm	-	P-2	-	0-2	T-2	E-2
216 air	41604	400	35	28	3,9mm	-	P-2	-	0-2	T-2	E-2
306	50310	260	19-21	18-20	-	5,0x50mm	P-3	-	0-3	T-3	E-2
310	50410	260	19-21	18-20	-	5,0x50mm	P-3	-	0-3	T-3	E-2
306 air	51310	260	19-21	18-20	-	5,0x50mm	P-3	-	0-3	T-3	E-2
310 air	51410	260	19-21	18-20	-	5,0x50mm	P-3	-	0-3	T-3	E-2
403	50114	240	8-10	7-9	-	4,0x40,0mm	P-4	F-1	-	T-4	E-3
404	50214	240	8-10	7-9	-	4,0x40,0mm	P-4	F-1	-	T-4	E-3
406	50314	260	17-19	15-17	-	4,0x40,0mm	P-4	F-1	0-3	T-4	E-3
410	50414	260	17-19	15-17	-	4,0x40,0mm	P-4	F-1	0-3	T-4	E-3
410 L plus	50464	310	25-27	24-26	-	4,0x40,0mm	P-4	F-1	0-3	T-4	E-3
414	50514	310	25-27	24-26	-	4,0x40,0mm	P-4	F-1	0-3	T-4	E-3
416	50564	400	19-21	18-20	-	4,0x40,0mm	P-4	F-1	0-3	T-4	E-3
404 air	51214	240	8-10	7-9	-	4,0x40,0mm	P-4	F-1	-	T-4	E-3
406 air	51314	260	17-19	15-17	-	4,0x40,0mm	P-4	F-1	0-3	T-4	E-3
410 air	51414	260	17-19	15-17	-	4,0x40,0mm	P-4	F-1	0-3	T-4	E-3
410 L plus air	51464	310	25-27	24-26	-	4,0x40,0mm	P-4	F-1	0-3	T-4	E-3







































		220-240V 50-60Hz	100-120V 50-60Hz				
	Vitesse en m/min				Dimensions h x l x p mm	Volume recueilli l	Poids kg
<=47dB/A	6,0	350W	400W	-	705x430x350	40	25,0
<=47dB/A	4,0	650W	680W	-	865x545x435	60	43,0
<=51dB/A	4,4	650W	680W	-	944x545x435	100	45,0
<=46dB/A	4,5	900W	900W	-	890x734x511	140	64,0
<=50dB/A	6,0	1650W	1650W	-	960x734x511	160	92,0
<=47dB/A	6,0	350W	400W	-	705x430x350	40	26,0
<=47dB/A	4,0	650W	680W	-	865x545x435	60	44,0
<=51dB/A	4,4	650W	680W	-	944x545x435	100	46,0
<=46dB/A	4,5	900W	900W	-	890x734x511	140	65,0
<=50dB/A	6,0	1650W	1650W	-	960x734x511	160	93,0
<=49dB/A	6,0	350W	400W	-	628x430x350	30	22,5
<=46dB/A	6,0	350W	400W	-	705x430x350	40	25,0
<=46dB/A	4,0	650W	680W	-	865x545x435	60	43,0
<=51dB/A	4,4	650W	680W	-	944x545x435	100	45,0
<=47dB/A	4,5	900W	900W	-	890x734x511	140	64,0
<=49dB/A	6,0	1650W	1650W	-	960x734x511	160	92,0
<=46dB/A	6,0	350W	400W	-	705x430x350	40	26,0
<=46dB/A	4,0	650W	680W	-	865x545x435	60	44,0
<=51dB/A	4,4	650W	680W	-	944x545x435	100	46,0
<=47dB/A	4,5	900W	900W	-	890x734x511	140	65,0
<=49dB/A	6,0	1650W	1650W	-	960x734x511	160	93,0
<=46dB/A	4,5	650W	680W	-	865x545x435	60	43,0
<=46dB/A	4,5	650W	680W	-	944x545x435	100	45,0
<=46dB/A	4,5	650W	680W	-	865x545x435	60	43,5
<=46dB/A	4,5	650W	680W	-	944x545x435	100	45,5
<=44dB/A	6,5	350W	400W	-	628x430x350	30	23,0
<=46dB/A	6,5	350W	400W	-	705x430x350	40	25,0
<=46dB/A	4,5	650W	680W	-	865x545x435	60	43,0
<=52dB/A	4,5	650W	680W	-	944x545x435	100	45,0
<=52dB/A	4,7	900W	900W	-	944x545x435	100	54,5
<=52dB/A	4,7	900W	900W	-	890x734x511	140	64,0
<=52dB/A	5,7	900W	900W	-	960x734x511	160	68,5
<=46dB/A	6,5	350W	400W	-	705x430x350	40	25,5
<=46dB/A	4,5	650W	680W	-	865x545x435	60	43,5
<=52dB/A	4,5	650W	680W	-	944x545x435	100	45,5
<=52dB/A	4,7	900W	900W	-	944x545x435	100	55,0



		Niveaux de sécurité selon la norme DIN 66399*									
							P	F	O	T	E
			DIN A4- 70g/m <sup>2</sup>	DIN A4- 80g/m <sup>2</sup>							
414 air	51514	310	25-27	24-26	-	4,0x40,0mm	P-4	F-1	0-3	T-4	E-3
416 air	51564	400	19-21	18-20	-	4,0x40,0mm	P-4	F-1	0-3	T-4	E-3
504	40222	240	6	5	-	2,0x15,0mm	P-5	F-2	-	T-5	E-4
506	50322	260	12-14	11-13	-	2,0x15,0mm	P-5	F-2	-	T-5	E-4
510	50422	260	12-14	11-13	-	2,0x15,0mm	P-5	F-2	-	T-5	E-4
510 L plus	50472	310	18-20	17-19	-	2,0x15,0mm	P-5	F-2	0-4	T-5	E-4
514	50522	310	18-20	17-19	-	2,0x15,0mm	P-5	F-2	0-4	T-5	E-4
516	50572	400	14-16	13-15	-	2,0x15,0mm	P-5	F-2	0-4	T-5	E-4
504 air	41222	240	6	5	-	2,0x15,0mm	P-5	F-2	-	T-5	E-4
506 air	51322	260	12-14	11-13	-	2,0x15,0mm	P-5	F-2	-	T-5	E-4
510 air	51422	260	12-14	11-13	-	2,0x15,0mm	P-5	F-2	-	T-5	E-4
510 L plus air	51472	310	18-20	17-19	-	2,0x15,0mm	P-5	F-2	0-4	T-5	E-4
514 air	51522	310	18-20	17-19	-	2,0x15,0mm	P-5	F-2	0-4	T-5	E-4
516 air	51572	400	14-16	13-15	-	2,0x15,0mm	P-5	F-2	0-4	T-5	E-4
604	40230	240	3	2	-	0,8x12,0mm	P-6	F-3	-	-	-
606	40330	260	6	5	-	0,8x12,0mm	P-6	F-3	-	T-6	-
610	40430	260	7	6	-	0,8x12,0mm	P-6	F-3	-	T-6	-
614	40530	310	11	9	-	0,8x12,0mm	P-6	F-3	-	T-6	-
616	40630	400	14	11	-	0,8x12,0mm	P-6	F-3	-	T-6	-
604 air	41230	240	3	2	-	0,8x12,0mm	P-6	F-3	-	-	-
606 air	41330	260	6	5	-	0,8x12,0mm	P-6	F-3	-	T-6	-
610 air	41430	260	7	6	-	0,8x12,0mm	P-6	F-3	-	T-6	-
614 air	41530	310	11	9	-	0,8x12,0mm	P-6	F-3	-	T-6	-
616 air	41630	400	14	11	-	0,8x12,0mm	P-6	F-3	-	T-6	-
706	40334	260	6	5	-	1,0x4,7mm	P-7	F-3	-	T-6	-
710	40434	260	6	5	-	1,0x4,7mm	P-7	F-3	-	T-6	-
710 L plus	40484	310	9	7	-	1,0x4,7mm	P-7	F-3	-	T-6	-
714	40534	310	9	7	-	1,0x4,7mm	P-7	F-3	-	T-6	-
716	40634	400	12	9	-	1,0x4,7mm	P-7	F-3	-	T-6	-
706 air	41334	260	6	5	-	1,0x4,7mm	P-7	F-3	-	T-6	-
710 air	41434	260	6	5	-	1,0x4,7mm	P-7	F-3	-	T-6	-
714 air	41534	310	9	7	-	1,0x4,7mm	P-7	F-3	-	T-6	-
716 air	41634	400	12	9	-	1,0x4,7mm	P-7	F-3	-	T-6	-



		220-240V 50-60Hz	100-120V 50-60Hz				
	Vitesse en m/min				Dimensions h x l x p mm	Volume recueilli l	Poids kg
≤52dB/A	4,7	900W	900W	-	890x734x511	140	64,5
≤52dB/A	5,7	900W	900W	-	960x734x511	160	69,0
≤47dB/A	6,0	350W	400W		705x430x350	40	25,0
≤46dB/A	4,4	650W	680W		865x545x435	60	44,0
≤53dB/A	4,4	650W	680W		944x545x435	100	46,0
≤53dB/A	4,8	900W	900W		944x545x435	100	59,0
≤52dB/A	4,8	900W	900W		890x734x511	140	68,5
≤53dB/A	5,6	900W	900W		960x734x511	160	75,0
≤47dB/A	6,0	350W	400W		705x430x350	40	26,0
≤46dB/A	4,4	650W	680W		865x545x435	60	43,0
≤53dB/A	4,4	650W	680W		944x545x435	100	47,0
≤53dB/A	4,8	900W	900W		944x545x435	100	60,0
≤53dB/A	4,8	900W	900W		890x734x511	140	69,5
≤53dB/A	5,6	900W	900W		960x734x511	160	76,0
≤50dB/A	6,0	350W	400W		705x430x350	40	25,0
≤47dB/A	3,5	650W	680W		865x545x435	60	43,0
≤52dB/A	4,3	650W	680W		944x545x435	100	45,0
≤50dB/A	4,5	900W	900W		890x734x511	140	64,0
≤50dB/A	4,0	1650W	1650W		960x734x511	160	92,0
≤50dB/A	6,0	350W	400W		705x430x350	40	26,0
≤47dB/A	3,5	650W	680W		865x545x435	60	44,0
≤52dB/A	4,3	650W	680W		944x545x435	100	46,0
≤50dB/A	4,5	900W	900W		890x734x511	140	65,0
≤50dB/A	4,0	1650W	1650W		960x734x511	160	93,0
≤50dB/A	6,5	650W	680W		865x545x435	60	43,0
≤52dB/A	6,5	650W	680W		944x545x435	100	45,0
≤52dB/A	7,0	900W	900W		944x545x435	100	60,0
≤52dB/A	7,0	900W	900W		890x734x511	140	64,0
≤52dB/A	8,0	1650W	1650W		960x734x511	160	92,0
≤50dB/A	6,5	650W	680W		865x545x435	60	44,0
≤52dB/A	6,5	650W	680W		944x545x435	100	46,0
≤52dB/A	7,0	900W	900W		890x734x511	140	65,0
≤52dB/A	8,0	1650W	1650W		960x734x511	160	93,0



1.

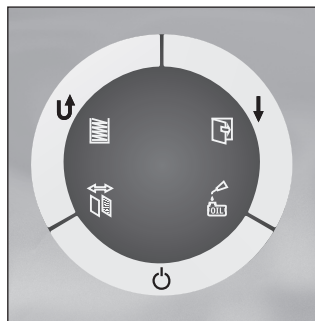

### Veillez respecter les consignes de sécurité.

1. Avant d'utiliser le destructeur de documents, vérifiez la position du bac de réception pour les CD/ DVD et les cartes bancaires/de crédit. Pour la destruction de documents en papier, ce bac doit se trouver à l'avant du bac de réception pour papier.
2. Fermez la porte du destructeur de documents.
3. Reliez le câble électrique fourni au destructeur de documents et à une prise de courant. Allumez l'interrupteur principal. Après la mise en marche grâce à l'interrupteur principal, attendez 2 à 3 secondes.
4. Allumez le destructeur de documents en actionnant la touche Marche, Arrêt, Stop.



1.1

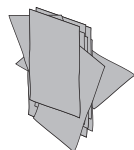

O.K.



1. **Tenir compte du nombre maximal de feuilles indiqué dans les Caractéristiques techniques !**
2. Introduisez le papier au centre de la fente d'alimentation ; le détecteur photoélectrique intégré met automatiquement en marche l'appareil.
3. Dès que la fente d'alimentation est à nouveau libre, le destructeur de documents s'arrête automatiquement et passe en veille.
4. **Avance continue** - lorsque vous maintenez la touche Marche avant enfoncée (durant 5 secondes environ), le destructeur de documents passe en mode d'avance continue.
5. Lorsque l'alimentation en papier est interrompue durant 15 secondes, l'avance continue est désactivée.



Selon le modèle, votre destructeur de documents ne comporte pas tous les composants et les fonctions indiqués.

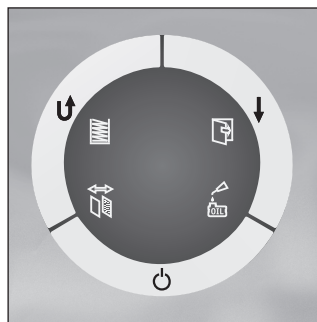
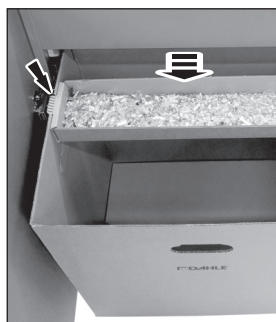

**Veillez respecter les consignes de sécurité : Pour détruire des CD et DVD, porter des lunettes de protection !**

1. Avant d'utiliser le destructeur de documents, vérifiez la position du bac de réception pour les CD/DVD et les cartes bancaires/de crédit. **Pour la destruction de CD/DVD et de cartes bancaires/de crédit**, celui-ci doit se trouver à l'arrière du bac de réception pour papier.
2. Dégagez le bac de réception et positionnez le bac de réception pour CD/DVD et cartes bancaires/de crédit vers l'arrière.
3. Fermez la porte du destructeur de documents.
4. Allumez le destructeur de documents en actionnant la touche Marche, Arrêt, Stop.



1. Insérez les CD/DVD ou les cartes bancaires/de crédit au centre de la fente d'alimentation et maintenez la touche Marche avant enfoncée.
2. Dès que la fente d'alimentation pour CD/DVD est à nouveau libre, l'appareil s'éteint automatiquement et passe en veille.



Selon le modèle, votre destructeur de documents ne comporte pas tous les composants et les fonctions indiqués.

## DAHLE CleanTEC®

### Remplacez le filtre à poussières fines Dahle

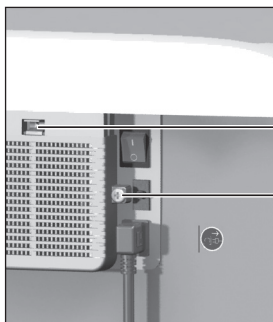
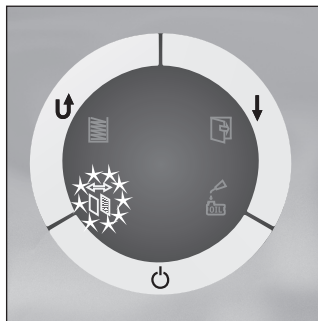

1. L'affichage de remplacement du filtre (**Remplacer le filtre à poussières fines DAHLE !**) s'allume sur le panneau de commande.
2. Débranchez le câble électrique de la prise de courant.
3. Changez le filtre à poussières fines au dos de l'appareil.
  - A. Dévisser la vis
  - B. Enfoncer le verrouillage et retirer le couvercle
  - C. Retirer le filtre et l'éliminer. Utiliser impérativement un **filtre à poussières fines DAHLE !**
  - D. Fermer le couvercle
  - E. Serrer la vis
4. Relevez le câble électrique à la prise de courant, actionnez l'interrupteur principal et la touche Marche, Arrêt, Stop.
5. Réinitialisation de l'affichage du changement de filtre : maintenez la touche Marche avant et Marche arrière enfoncée simultanément durant 5 secondes environ.

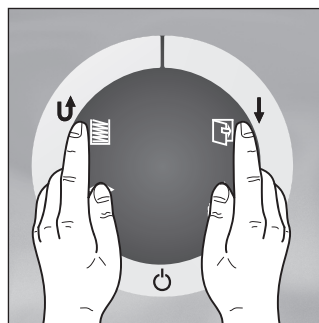

Nous déclinons toute responsabilité si le filtre à poussières fines DAHLE est mal utilisé ou n'est pas remplacé quand il le faut. Les filtres à poussières fines DAHLE usagés peuvent être jetés dans les ordures ménagères. Les particules de poussière sont prises dans le filtre DAHLE. Veuillez éliminer le filtre à poussières fines DAHLE de telle manière qu'il ne risque pas de tomber dans les mains d'enfants.



Selon le modèle, votre destructeur de documents ne comporte pas tous les composants et les fonctions indiqués.

## Lubrification automatique (uniquement pour les coupes en particules P5, P6 et P7)

Remplir le réservoir d'huile pour destructeurs de documents DAHLE.

Réservoir d'huile intégré pour une lubrification automatique autorégulée des rouleaux.

! 2.

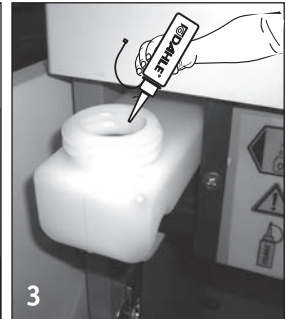
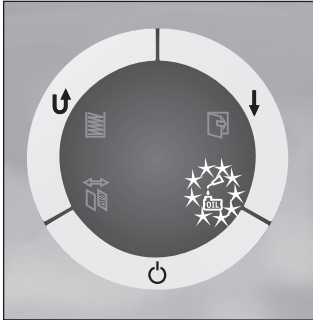

Lorsque l'affichage vous y invite, remplissez le réservoir d'huile intégré au destructeur de documents.

1. Éteignez le destructeur de documents en actionnant la touche Marche, Arrêt, Stop.
2. Ouvrez la porte. Le réservoir d'huile intégré se trouve dans l'armoire. Ouvrez le bouchon.
3. Remplissez le **réservoir d'huile** (utilisez de l'huile pour destructeurs de documents DAHLE !) et refermez-le.



Selon le modèle, votre destructeur de documents ne comporte pas tous les composants et les fonctions indiqués.

**Bac de réception plein – Le voyant clignote.**

3.

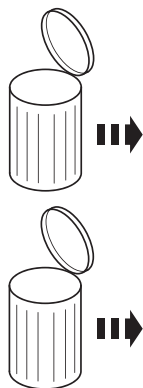
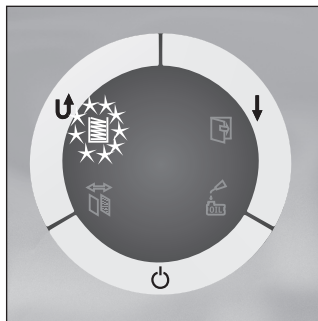

1. Lorsque le bac de réception est plein, la coupe s'interrompt et un signal visuel vous en avertit.
2. Éteignez l'interrupteur principal et débranchez le câble de la prise de courant.
3. Retirez le bac de réception, videz-le, puis remettez-le en place.
4. Branchez le câble électrique sur la prise de courant et rallumez l'interrupteur principal.





Selon le modèle, votre destructeur de documents ne comporte pas tous les composants et les fonctions indiqués.

**Arrêt automatique du moteur** - Les voyants du niveau de remplissage et de la porte clignotent.

4.

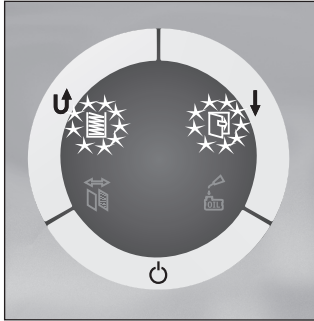

1. Arrêt automatique du moteur dans les cas suivants :
  - surchauffe du moteur
  - bourrage de papier

**Porte ouverte** - Le voyant clignote.

5.

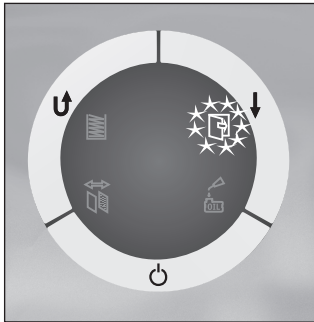

1. Lorsque la porte est ouverte, la coupe s'arrête et le voyant clignote ; fermez alors la porte.

Selon le modèle, votre destructeur de documents ne comporte pas tous les composants et les fonctions indiqués.

? 1.

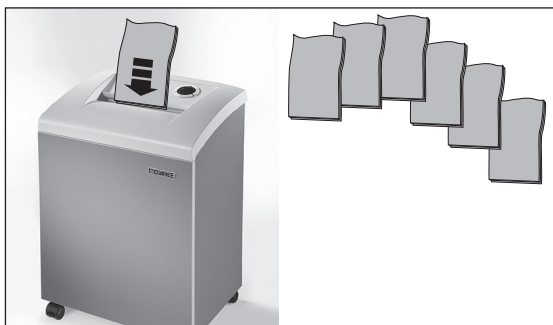

Le destructeur de documents s'éteint automatiquement après une utilisation prolongée et/ou en cas de surcharge afin de refroidir.

? 2.



Interrupteur à protection thermique

### La coupe ne démarre pas :

- Le câble électrique est-il bien relié à la prise de courant ?
- L'interrupteur principal est-il bien allumé ?
- La touche Marche, Arrêt, Stop est-elle bien allumée ?
- La porte est-elle ouverte ?
- Le bac de réception est-il plein ?
- L'appareil est-il en surcharge/en surchauffe ?
- L'interrupteur à protection thermique est-il sur OFF ?

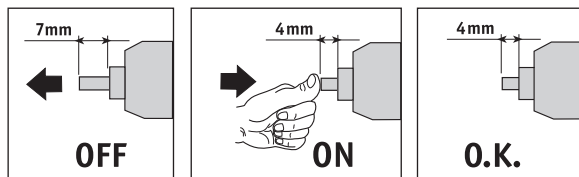

Amenez l'interrupteur à protection thermique en position ON.

Selon le modèle, votre destructeur de documents ne comporte pas tous les composants et les fonctions indiqués.

3.

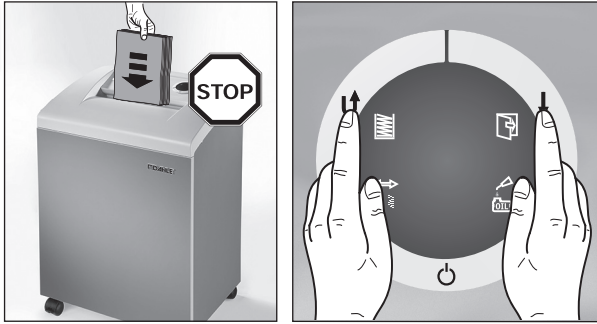

1. S'il y a trop de feuilles, la coupe s'interrompt.
2. Le système de coupe redémarre de lui-même brièvement en marche arrière afin de faire ressortir le papier.
3. **ATTENTION : ne pas actionner alternativement l'interrupteur de marche avant et de marche arrière afin de ne pas abîmer le mécanisme de coupe !**

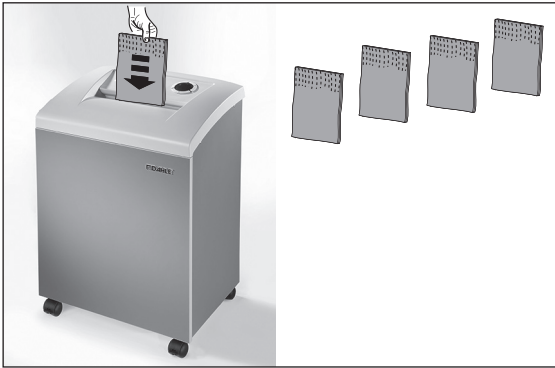

4. Si le papier est toujours bloqué, appuyez brièvement sur la touche Marche arrière.
5. Diminuez le nombre de feuilles en retirant ou déchirant quelques feuilles.
6. Lorsque vous insérez à nouveau le papier, la coupe redémarre automatiquement ; si ce n'est pas le cas, actionnez la touche Marche avant.

**706, 710, 710 L plus, 714, 716, 706 air, 710 air, 714 air, 716 air**

1. En cas de bourrage de papier, le système de coupe fonctionne en marche arrière durant 0,5 seconde.
2. Retirez le papier. Actionnez ensuite l'interrupteur Marche avant pour libérer le système de coupe.  
L'interrupteur Marche arrière est bloqué jusqu'à ce que l'interrupteur Marche avant soit actionné.
3. Retirez quelques feuilles.



Selon le modèle, votre destructeur de documents ne comporte pas tous les composants et les fonctions indiqués.

## Mode d'économie d'énergie

? 4.



Le destructeur de documents s'arrête après environ 30 minutes de non-utilisation (le voyant s'éteint). Pour vous servir à nouveau du destructeur de documents, rallumez-le en appuyant sur la touche Marche, Arrêt, Stop.



Utilisez uniquement des pièces détachées DAHLE !

## Lubrification (coupe en particules P5)



Lubrifiez le dispositif de coupe lorsque les performances décroissent, après chaque vidange du bac de réception ou au plus tard au terme d'une durée de fonctionnement inscrite sur la notice d'avertissement **(uniquement coupe en particules P5)**.

1. Éteignez le destructeur de documents en actionnant la touche Marche, Arrêt, Stop. Lubrifiez les rouleaux de coupe manuellement (utilisez de l'huile pour destructeurs de documents DAHLE !).
2. Allumez le destructeur de documents en actionnant la touche Marche, Arrêt, Stop et laissez le système de coupe fonctionner pendant 10 secondes en marche arrière sans l'alimenter en papier.

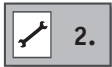

1. Éteignez le destructeur de documents et débranchez le câble de la prise de courant.
2. Utilisez uniquement un chiffon sec pour nettoyer l'appareil.
3. Branchez le câble électrique sur la prise de courant et rallumez le destructeur de documents.





**¡Lea detenidamente las instrucciones de uso y las indicaciones sobre seguridad antes de poner en marcha la destructora! Deben cumplirse todas las indicaciones. Guarde las instrucciones por si las necesita en otro momento.**

- La destructora debe guardarse, transportarse y utilizarse solo en posición vertical.
- Emplear para la destructora exclusivamente líquidos y gases que cumplan las directivas de DAHLE.
- La destructora debe utilizarse en espacios cerrados a temperaturas entre 15 °C y 32 °C (50 °F - 90 °F) y con una humedad del aire no condensante entre el 15% y el 95%.
- La destructora no debe colocarse cerca de una fuente de calor.
- La destructora debe colocarse en un lugar firme y en una posición estable, a una distancia mínima de 100 mm de la pared. Accione los frenos de fijación y fijela con el set de montaje eventualmente adjunto.
- Evite la acumulación de calor.
- El enchufe debe estar fácilmente accesible en todo momento.
- Utilice únicamente el cable de red que incluye la empresa DAHLE y compruebe que no esté dañado.
- La instalación eléctrica del edificio deberá estar protegida contra cortocircuitos: máx. 16 A (para EE.UU. máx. 20 A).
- No utilice cerca de líquidos ni de gases inflamables.
- No utilizar cerca de sustancias corrosivas.
- No exponer a la humedad.
- No abrir el aparato.
- Inicio automático.
- La destructora nunca debe funcionar en vacío.
- Cuando no se esté utilizando, apagar la destructora mediante el interruptor principal.
- Ponga la destructora en funcionamiento solo si está en perfecto estado observando el manual de instrucciones, las directrices y normas habituales, así como las normas de seguridad y de prevención de accidentes aplicables. En caso de avería, la destructora deberá ponerse inmediatamente fuera de servicio.
- El aparato no está destinado a su uso por parte de personas (incluidos niños) con facultades físicas, sensoriales o mentales reducidas o con falta de experiencia y conocimiento, salvo que lo utilicen bajo la supervisión de una persona que se responsabilice de la seguridad o esta les haya instruido de forma detallada en el manejo del aparato.



- 1 - Deben cumplirse todas las normas de seguridad.
- 2 - **Lea detenidamente las instrucciones de uso y las indicaciones sobre seguridad antes de poner en marcha la destructora.**
- 3 - Esta destructora no está destinada a ser utilizada por niños (el producto no es un juguete).
- 4 - No tocar el alimentador de papel con las manos.
- 5 - No tocar el alimentador de papel con piezas de ropa.
- 6 - No tocar el alimentador de papel con el cabello.
- 7 - Antes de realizar los trabajos de mantenimiento, desconecte la destructora de alimentación de la corriente.
- 8 - Póngase gafas protectoras cuando vaya a triturar CD/DVD.
- 9 - Antes de destruir papel, retirar todos los clips y grapas que pueda llevar.  
(equipos de nivel de seguridad P6 y P7)



## ¡Observar las advertencias!



- <sup>1</sup> - Volumen en funcionamiento en vacío (según DIN)
- <sup>2</sup> - Destructor lista para ser utilizada
- <sup>3</sup> - Destructor en funcionamiento
- <sup>4</sup> - Inicio automático
- <sup>5</sup> - Aceites (¡utilice únicamente aceite DAHLE!)
- <sup>6</sup> - Deseche la destructora debidamente y de forma respetuosa con el medio ambiente en un centro autorizado de recogida de residuos.  
No deseche ninguna pieza de la destructora ni del embalaje en la basura doméstica.

## Utilización conforme al uso prescrito, garantía

La destructora está destinada a triturar papel. Según la variante del modelo, se puede triturar además una pequeña cantidad de los siguientes materiales:

- CD/DVD, tarjetas bancarias y de crédito (véase Datos técnicos).
- Los clips y grapas que lleven los documentos en papel, dentro de los límites del uso habitual (excepción: equipos de nivel de seguridad P6 y P7).

La garantía no cubre el desgaste, los daños causados por uso indebido ni las consecuencias de una manipulación por parte de terceros.

La destructora está pensada para su uso por particulares y en entornos normales de oficina.

Los datos técnicos relativos a la alimentación de papel están sujetos a las siguientes condiciones: Cantidad máxima de hojas cortadas de una vez en las siguientes condiciones: Tambor de corte nuevo y engrasado (si procede), motor en frío, corriente eléctrica con tensión y frecuencia nominal (230V/50Hz; 120V/60Hz). Las variaciones pueden repercutir en una reducción de la alimentación de papel y en un aumento de los ruidos de funcionamiento. Las hojas se deben introducir centradas y a lo largo a 90°. La capacidad de alimentación del papel también puede variar dependiendo de las características del papel y el modo de introducirlo.

## ¡Reservado el derecho a modificaciones técnicas!

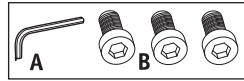
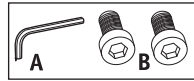
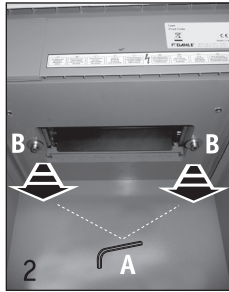

**¡Retire la seguridad del transporte!**

1. Accione el freno de fijación. Antes de la primera puesta en marcha, abra la puerta y retire el depósito colector de papel.
2. Extraiga los tornillos de la seguridad del transporte (zona de inserción del depósito colector de papel) de la placa del fondo debajo de la barra de corte, vuelva a introducir el depósito colector de papel y cierre la puerta.
3. Cada vez que cambie el emplazamiento de la trituradora, deberá volver a colocar la seguridad del transporte.

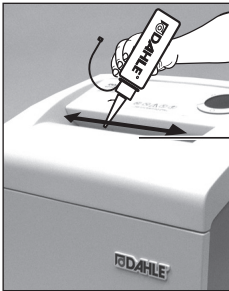

1



2

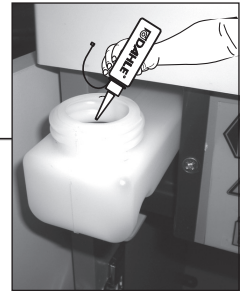

1. Engrase los rodillos de corte con el aceite de la destructora DAHLE (solo corte en partículas).
2. Rellene el depósito de aceite con aceite de la destructora DAHLE.



# Indicaciones generales

Según la variante del modelo, su destructora no dispondrá de todos los componentes y funciones posibles.

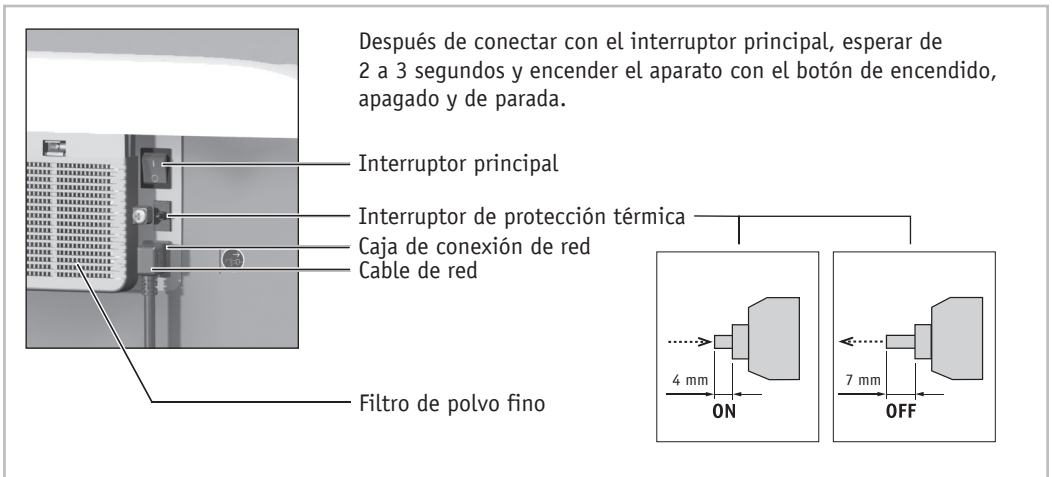
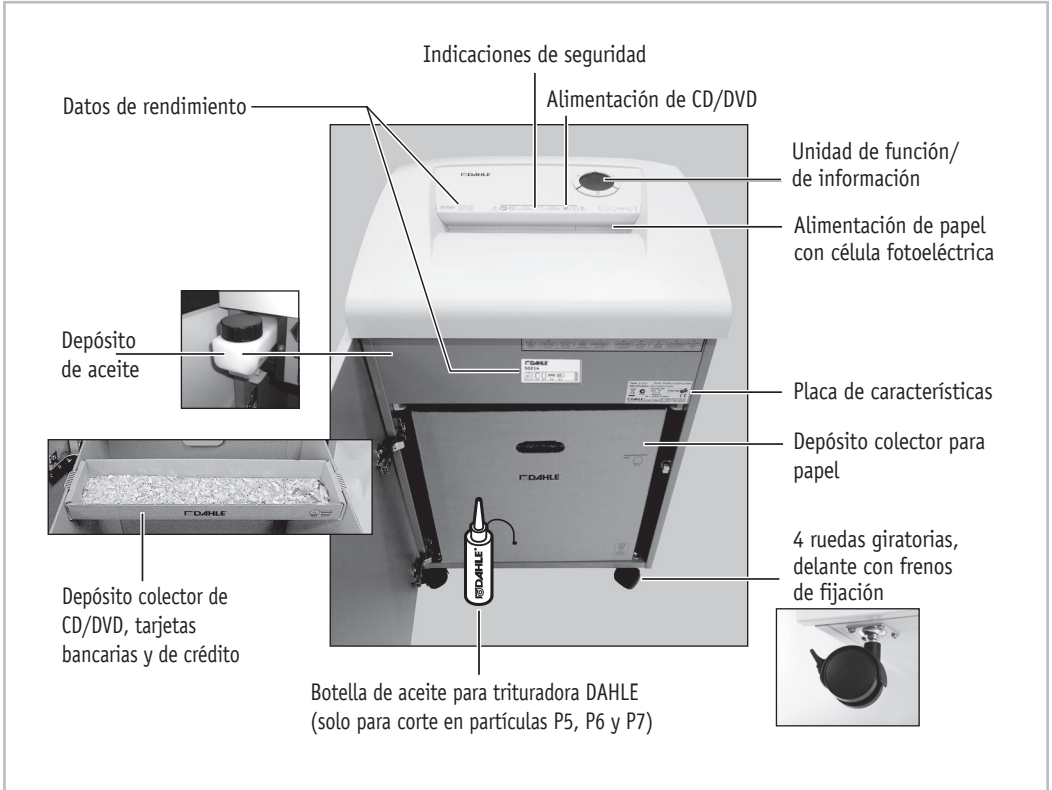

Según la variante del modelo, su destructora no dispondrá de todos los componentes y funciones posibles.

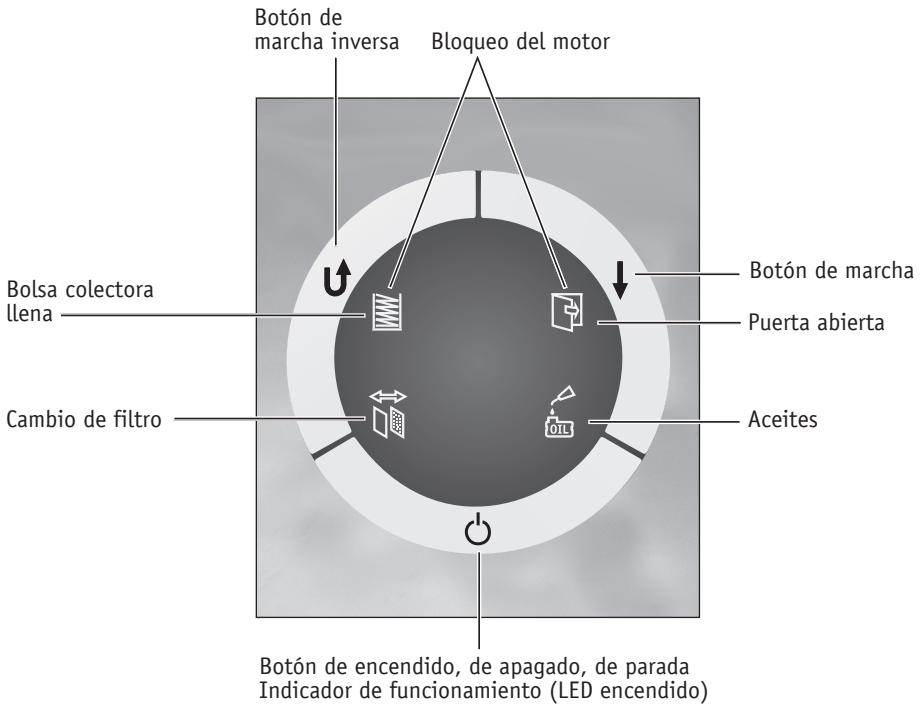

Type  
Prod. Code

XXX-XXX V  
XX Hz







1. Compruebe que la tensión y la frecuencia de red de su red eléctrica coincide con las indicaciones de la placa de características.











							Niveles de seguridad según DIN 66399*				
							P	F	0	T	E
			DIN A4- 70g/m <sup>2</sup>	DIN A4- 80g/m <sup>2</sup>							
104	40206	240	19	16	5,8mm	-	P-2	-	0-2	T-2	E-2
106	40306	260	27	22	5,8mm	-	P-2	-	0-2	T-2	E-2
110	40406	260	29	23	5,8mm	-	P-2	-	0-2	T-2	E-2
114	40506	310	43	35	5,8mm	-	P-2	-	0-2	T-2	E-2
116	40606	400	45	36	5,8mm	-	P-2	-	0-2	T-2	E-2
104 air	41206	240	19	16	5,8mm	-	P-2	-	0-2	T-2	E-2
106 air	41306	260	27	22	5,8mm	-	P-2	-	0-2	T-2	E-2
110 air	41406	260	29	23	5,8mm	-	P-2	-	0-2	T-2	E-2
114 air	41506	310	43	35	5,8mm	-	P-2	-	0-2	T-2	E-2
116 air	41606	400	45	36	5,8mm	-	P-2	-	0-2	T-2	E-2
203	40104	220	15	13	3,9mm	-	P-2	-	-	T-2	E-2
204	40204	240	17	14	3,9mm	-	P-2	-	-	T-2	E-2
206	40304	260	23	18	3,9mm	-	P-2	-	0-2	T-2	E-2
210	40404	260	24	19	3,9mm	-	P-2	-	0-2	T-2	E-2
214	40504	310	33	26	3,9mm	-	P-2	-	0-2	T-2	E-2
216	40604	400	35	28	3,9mm	-	P-2	-	0-2	T-2	E-2
204 air	41204	240	17	14	3,9mm	-	P-2	-	-	T-2	E-2
206 air	41304	260	23	18	3,9mm	-	P-2	-	0-2	T-2	E-2
210 air	41404	260	24	19	3,9mm	-	P-2	-	0-2	T-2	E-2
214 air	41504	310	33	26	3,9mm	-	P-2	-	0-2	T-2	E-2
216 air	41604	400	35	28	3,9mm	-	P-2	-	0-2	T-2	E-2
306	50310	260	19-21	18-20	-	5,0x50mm	P-3	-	0-3	T-3	E-2
310	50410	260	19-21	18-20	-	5,0x50mm	P-3	-	0-3	T-3	E-2
306 air	51310	260	19-21	18-20	-	5,0x50mm	P-3	-	0-3	T-3	E-2
310 air	51410	260	19-21	18-20	-	5,0x50mm	P-3	-	0-3	T-3	E-2
403	50114	240	8-10	7-9	-	4,0x40,0mm	P-4	F-1	-	T-4	E-3
404	50214	240	8-10	7-9	-	4,0x40,0mm	P-4	F-1	-	T-4	E-3
406	50314	260	17-19	15-17	-	4,0x40,0mm	P-4	F-1	0-3	T-4	E-3
410	50414	260	17-19	15-17	-	4,0x40,0mm	P-4	F-1	0-3	T-4	E-3
410 L plus	50464	310	25-27	24-26	-	4,0x40,0mm	P-4	F-1	0-3	T-4	E-3
414	50514	310	25-27	24-26	-	4,0x40,0mm	P-4	F-1	0-3	T-4	E-3
416	50564	400	19-21	18-20	-	4,0x40,0mm	P-4	F-1	0-3	T-4	E-3
404 air	51214	240	8-10	7-9	-	4,0x40,0mm	P-4	F-1	-	T-4	E-3
406 air	51314	260	17-19	15-17	-	4,0x40,0mm	P-4	F-1	0-3	T-4	E-3
410 air	51414	260	17-19	15-17	-	4,0x40,0mm	P-4	F-1	0-3	T-4	E-3
410 L plus air	51464	310	25-27	24-26	-	4,0x40,0mm	P-4	F-1	0-3	T-4	E-3





































		220-240V 50-60Hz	100-120V 50-60Hz				
	Velocidad m/min				Medidas Al x An x Pr mm	Volumen del colector l	Peso kg
<=47dB/A	6,0	350W	400W	-	705x430x350	40	25,0
<=47dB/A	4,0	650W	680W	-	865x545x435	60	43,0
<=51dB/A	4,4	650W	680W	-	944x545x435	100	45,0
<=46dB/A	4,5	900W	900W	-	890x734x511	140	64,0
<=50dB/A	6,0	1650W	1650W	-	960x734x511	160	92,0
<=47dB/A	6,0	350W	400W	-	705x430x350	40	26,0
<=47dB/A	4,0	650W	680W	-	865x545x435	60	44,0
<=51dB/A	4,4	650W	680W	-	944x545x435	100	46,0
<=46dB/A	4,5	900W	900W	-	890x734x511	140	65,0
<=50dB/A	6,0	1650W	1650W	-	960x734x511	160	93,0
<=49dB/A	6,0	350W	400W	-	628x430x350	30	22,5
<=46dB/A	6,0	350W	400W	-	705x430x350	40	25,0
<=46dB/A	4,0	650W	680W	-	865x545x435	60	43,0
<=51dB/A	4,4	650W	680W	-	944x545x435	100	45,0
<=47dB/A	4,5	900W	900W	-	890x734x511	140	64,0
<=49dB/A	6,0	1650W	1650W	-	960x734x511	160	92,0
<=46dB/A	6,0	350W	400W	-	705x430x350	40	26,0
<=46dB/A	4,0	650W	680W	-	865x545x435	60	44,0
<=51dB/A	4,4	650W	680W	-	944x545x435	100	46,0
<=47dB/A	4,5	900W	900W	-	890x734x511	140	65,0
<=49dB/A	6,0	1650W	1650W	-	960x734x511	160	93,0
<=46dB/A	4,5	650W	680W	-	865x545x435	60	43,0
<=46dB/A	4,5	650W	680W	-	944x545x435	100	45,0
<=46dB/A	4,5	650W	680W	-	865x545x435	60	43,5
<=46dB/A	4,5	650W	680W	-	944x545x435	100	45,5
<=44dB/A	6,5	350W	400W	-	628x430x350	30	23,0
<=46dB/A	6,5	350W	400W	-	705x430x350	40	25,0
<=46dB/A	4,5	650W	680W	-	865x545x435	60	43,0
<=52dB/A	4,5	650W	680W	-	944x545x435	100	45,0
<=52dB/A	4,7	900W	900W	-	944x545x435	100	54,5
<=52dB/A	4,7	900W	900W	-	890x734x511	140	64,0
<=52dB/A	5,7	900W	900W	-	960x734x511	160	68,5
<=46dB/A	6,5	350W	400W	-	705x430x350	40	25,5
<=46dB/A	4,5	650W	680W	-	865x545x435	60	43,5
<=52dB/A	4,5	650W	680W	-	944x545x435	100	45,5
<=52dB/A	4,7	900W	900W	-	944x545x435	100	55,0



		Niveles de seguridad según DIN 66399*									
							P	F	0	T	E
			DIN A4-70g/m <sup>2</sup>	DIN A4-80g/m <sup>2</sup>							
414 air	51514	310	25-27	24-26	-	4,0x40,0mm	P-4	F-1	0-3	T-4	E-3
416 air	51564	400	19-21	18-20	-	4,0x40,0mm	P-4	F-1	0-3	T-4	E-3
504	40222	240	6	5	-	2,0x15,0mm	P-5	F-2	-	T-5	E-4
506	50322	260	12-14	11-13	-	2,0x15,0mm	P-5	F-2	-	T-5	E-4
510	50422	260	12-14	11-13	-	2,0x15,0mm	P-5	F-2	-	T-5	E-4
510 L plus	50472	310	18-20	17-19	-	2,0x15,0mm	P-5	F-2	0-4	T-5	E-4
514	50522	310	18-20	17-19	-	2,0x15,0mm	P-5	F-2	0-4	T-5	E-4
516	50572	400	14-16	13-15	-	2,0x15,0mm	P-5	F-2	0-4	T-5	E-4
504 air	41222	240	6	5	-	2,0x15,0mm	P-5	F-2	-	T-5	E-4
506 air	51322	260	12-14	11-13	-	2,0x15,0mm	P-5	F-2	-	T-5	E-4
510 air	51422	260	12-14	11-13	-	2,0x15,0mm	P-5	F-2	-	T-5	E-4
510 L plus air	51472	310	18-20	17-19	-	2,0x15,0mm	P-5	F-2	0-4	T-5	E-4
514 air	51522	310	18-20	17-19	-	2,0x15,0mm	P-5	F-2	0-4	T-5	E-4
516 air	51572	400	14-16	13-15	-	2,0x15,0mm	P-5	F-2	0-4	T-5	E-4
604	40230	240	3	2	-	0,8x12,0mm	P-6	F-3	-	-	-
606	40330	260	6	5	-	0,8x12,0mm	P-6	F-3	-	T-6	-
610	40430	260	7	6	-	0,8x12,0mm	P-6	F-3	-	T-6	-
614	40530	310	11	9	-	0,8x12,0mm	P-6	F-3	-	T-6	-
616	40630	400	14	11	-	0,8x12,0mm	P-6	F-3	-	T-6	-
604 air	41230	240	3	2	-	0,8x12,0mm	P-6	F-3	-	-	-
606 air	41330	260	6	5	-	0,8x12,0mm	P-6	F-3	-	T-6	-
610 air	41430	260	7	6	-	0,8x12,0mm	P-6	F-3	-	T-6	-
614 air	41530	310	11	9	-	0,8x12,0mm	P-6	F-3	-	T-6	-
616 air	41630	400	14	11	-	0,8x12,0mm	P-6	F-3	-	T-6	-
706	40334	260	6	5	-	1,0x4,7mm	P-7	F-3	-	T-6	-
710	40434	260	6	5	-	1,0x4,7mm	P-7	F-3	-	T-6	-
710 L plus	40484	310	9	7	-	1,0x4,7mm	P-7	F-3	-	T-6	-
714	40534	310	9	7	-	1,0x4,7mm	P-7	F-3	-	T-6	-
716	40634	400	12	9	-	1,0x4,7mm	P-7	F-3	-	T-6	-
706 air	41334	260	6	5	-	1,0x4,7mm	P-7	F-3	-	T-6	-
710 air	41434	260	6	5	-	1,0x4,7mm	P-7	F-3	-	T-6	-
714 air	41534	310	9	7	-	1,0x4,7mm	P-7	F-3	-	T-6	-
716 air	41634	400	12	9	-	1,0x4,7mm	P-7	F-3	-	T-6	-

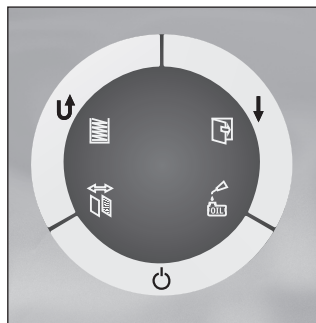

	Velocidad m/min	220-240V 50-60Hz	100-120V 50-60Hz		Medidas Al x An x Pr mm	Volumen del colector l	Peso kg
							
<=52dB/A	4,7	900W	900W	-	890x734x511	140	64,5
<=52dB/A	5,7	900W	900W	-	960x734x511	160	69,0
<=47dB/A	6,0	350W	400W		705x430x350	40	25,0
<=46dB/A	4,4	650W	680W		865x545x435	60	44,0
<=53dB/A	4,4	650W	680W		944x545x435	100	46,0
<=53dB/A	4,8	900W	900W		944x545x435	100	59,0
<=52dB/A	4,8	900W	900W		890x734x511	140	68,5
<=53dB/A	5,6	900W	900W		960x734x511	160	75,0
<=47dB/A	6,0	350W	400W		705x430x350	40	26,0
<=46dB/A	4,4	650W	680W		865x545x435	60	43,0
<=53dB/A	4,4	650W	680W		944x545x435	100	47,0
<=53dB/A	4,8	900W	900W		944x545x435	100	60,0
<=53dB/A	4,8	900W	900W		890x734x511	140	69,5
<=53dB/A	5,6	900W	900W		960x734x511	160	76,0
<=50dB/A	6,0	350W	400W		705x430x350	40	25,0
<=47dB/A	3,5	650W	680W		865x545x435	60	43,0
<=52dB/A	4,3	650W	680W		944x545x435	100	45,0
<=50dB/A	4,5	900W	900W		890x734x511	140	64,0
<=50dB/A	4,0	1650W	1650W		960x734x511	160	92,0
<=50dB/A	6,0	350W	400W		705x430x350	40	26,0
<=47dB/A	3,5	650W	680W		865x545x435	60	44,0
<=52dB/A	4,3	650W	680W		944x545x435	100	46,0
<=50dB/A	4,5	900W	900W		890x734x511	140	65,0
<=50dB/A	4,0	1650W	1650W		960x734x511	160	93,0
<=50dB/A	6,5	650W	680W		865x545x435	60	43,0
<=52dB/A	6,5	650W	680W		944x545x435	100	45,0
<=52dB/A	7,0	900W	900W		944x545x435	100	60,0
<=52dB/A	7,0	900W	900W		890x734x511	140	64,0
<=52dB/A	8,0	1650W	1650W		960x734x511	160	92,0
<=50dB/A	6,5	650W	680W		865x545x435	60	44,0
<=52dB/A	6,5	650W	680W		944x545x435	100	46,0
<=52dB/A	7,0	900W	900W		890x734x511	140	65,0
<=52dB/A	8,0	1650W	1650W		960x734x511	160	93,0

**Tenga en cuenta las indicaciones de seguridad.**

1. Antes de utilizar la destructora, compruebe la posición del depósito colector de CD/DVD y de tarjetas bancarias y de crédito. Para triturar papel, este debe estar situado en la parte delantera del colector de papel.
2. Cierre la puerta de la destructora.
3. Conecte el cable de red suministrado a la destructora y a un enchufe. Conecte el interruptor principal. Una vez conectado el interruptor principal, esperar de 2 a 3 segundos.
4. Conecte la destructora con el botón de encendido, apagado y de parada.

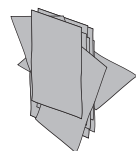
**O.K.****1. ¡Tenga en cuenta en número máximo de páginas que aparece en Datos técnicos!**

2. Introduzca el papel en el centro del alimentador, la alimentación de papel incorporada iniciará automáticamente la destructora.
3. Después de que la alimentación de papel vuelva a estar libre, la destructora se apaga automáticamente y pasa a estar lista para funcionar.
4. Marcha constante - Tras pulsar seguidamente el botón de marcha (aprox. 5 s), la trituradora pasa a marcha constante.
5. Si la alimentación de papel se interrumpe durante 15 segundos, la marcha constante se **desconecta**.





Según la variante del modelo, su destructora no dispondrá de todos los componentes y funciones posibles.

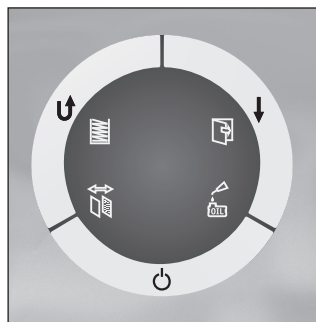
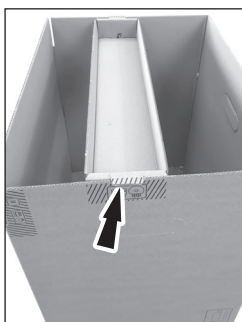
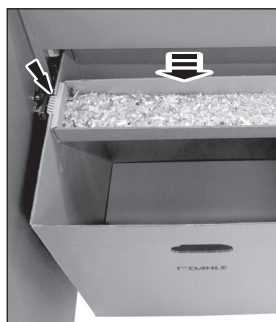

**Tenga en cuenta las indicaciones de seguridad: póngase gafas protectoras cuando vaya a triturar CD/DVD.**

1. Antes de utilizar la destructora, compruebe la posición del depósito colector de CD/DVD y de tarjetas bancarias y de crédito. Para triturar CD/DVD y tarjetas bancarias y de crédito, deben estar situados en la parte delantera del colector de papel.
2. Extraiga el depósito colector y posicione el depósito colector para CD/DVD, tarjetas de crédito y bancarias hacia atrás.
3. Cierre la puerta de la destructora.
4. Conecte la destructora con el botón de encendido, apagado y de parada.



1. Introduzca los CD/DVD o las tarjetas bancarias/de crédito en el centro de la alimentación y mantenga pulsado el botón de marcha.
2. Después de que la alimentación de CD/DVD vuelva a estar libre, la destructora se apaga automáticamente y pasa a estar lista para funcionar.



Según la variante del modelo, su destructora no dispondrá de todos los componentes y funciones posibles.

## DAHLE CleanTEC®

### Cambiar el filtro de polvo fino Dahle

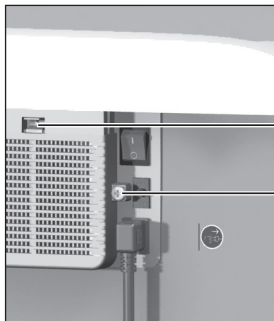
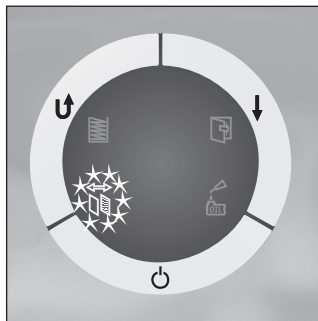
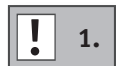

Seguro

Tornillo

1. La indicación Cambio de filtro (**cambiar filtro de polvo fino DAHLE**) se ilumina en el panel de control.
2. Desconecte el cable de red del enchufe.
3. Cambie el filtro de polvo fino en la parte posterior del aparato.
  - A. Desenrosque el tornillo
  - B. Presione el seguro y retire la tapa
  - C. Extraiga el filtro y deséchelo. ¡Es absolutamente necesario que vuelva a colocar **el filtro de polvo fino DAHLE!**
  - D. Cierre la tapa
  - E. Apriete el tornillo
4. Conecte el cable de red con el enchufe, conecte el interruptor principal y los botones de encendido, apagado y parada.
5. Reinicie la indicación del cambio de filtro: mantenga pulsado aprox. durante 5 segundos el botón de marcha y de marcha inversa simultáneamente.

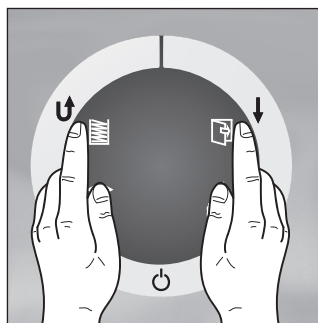

No asumimos ninguna responsabilidad por la aplicación incorrecta del filtro de polvo fino y por no cambiar el filtro de polvo fino DAHLE.

El filtro de polvo fino DAHLE utilizado puede eliminarse en la basura doméstica.

Las partículas de polvo fino quedan adheridas al filtro de polvo fino DAHLE.

Deseché el filtro de polvo fino DAHLE de forma que los niños no puedan acceder a él.



Según la variante del modelo, su destructora no dispondrá de todos los componentes y funciones posibles.

## Engrase automático (solo para corte en partículas P5, P6 y P7).

Rellene el depósito de aceite con aceite de destructora DAHLE.

Depósito de aceite integrado para engrasar de forma regulada y automática los rodillos.

! 2.

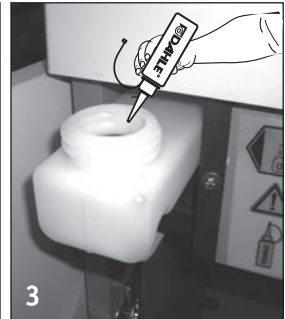
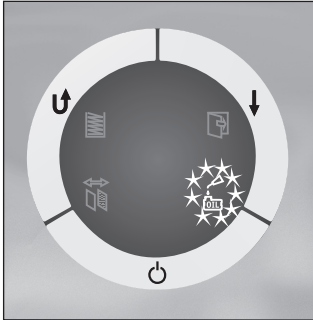

Rellene el depósito de aceite integrado en la destructora cuando se indique en la pantalla.

1. Conecte la destructora con el botón de encendido, apagado y de parada.
2. Abra la puerta, en el compartimento se encuentra el depósito de aceite integrado, abra el tapón de cierre.
3. Rellene el depósito de aceite con aceite (¡utilice aceite de destructora DAHLE!) y vuelva a cerrarlo.



Según la variante del modelo, su destructor no dispondrá de todos los componentes y funciones posibles.

**Depósito colector lleno:** El LED parpadea

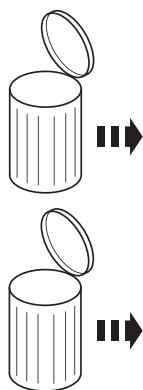
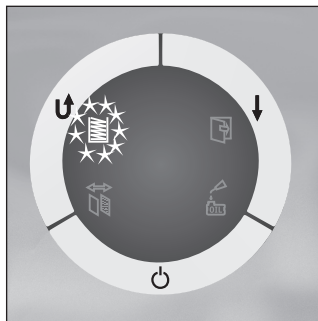

1. En caso de que el depósito colector esté lleno, el proceso de trituración se detendrá. Esto se muestra de forma óptica.
2. Apague el interruptor principal y desenchufe el cable de red del enchufe.
3. Extraiga el depósito colector, vacíelo y colóquelo de nuevo.
4. Conecte el cable de red a un enchufe y encienda el interruptor principal.



Según la variante del modelo, su destructor no dispondrá de todos los componentes y funciones posibles.

**Desconexión automática del motor:** Los LED del nivel de llenado y de puerta parpadean.

**!** 4.

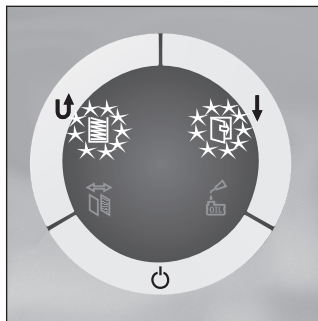

1. El motor se desconecta automáticamente si:
  - el motor se sobrecalienta
  - se produce un atasco de papel

**Puerta abierta:** El LED parpadea

**!** 5.

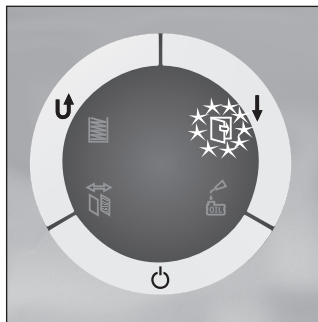

1. En caso de que la puerta esté abierta, el proceso de trituración se detendrá y el LED parpadeará. Cierre la puerta.



Según la variante del modelo, su destructor no dispondrá de todos los componentes y funciones posibles.

? 1.

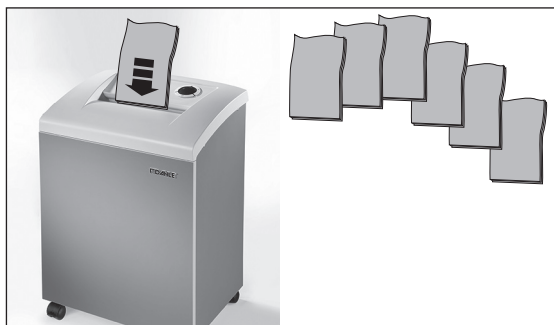

La destructora se apaga automáticamente después de haber estado en funcionamiento durante mucho tiempo y/o después de sobrecarga para enfriarse.

? 2.



Interruptor de protección térmica

#### No se inicia el proceso de trituración:

- El cable de red no está conectado al enchufe
- ¿Está conectado el interruptor principal?
- ¿Está encendido el botón de encendido, de apagado, de parada?
- Abrir la puerta
- Depósito colector lleno
- ¿Aparato sobrecargado/sobrecalentado?
- ¿Está apagado el interruptor de protección térmica?

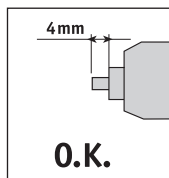
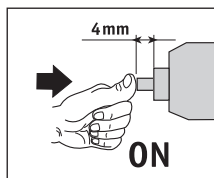
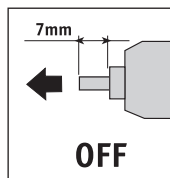

Coloque el interruptor de protección térmica en la posición correcta: ON.

Según la variante del modelo, su destructora no dispondrá de todos los componentes y funciones posibles.

? 3.

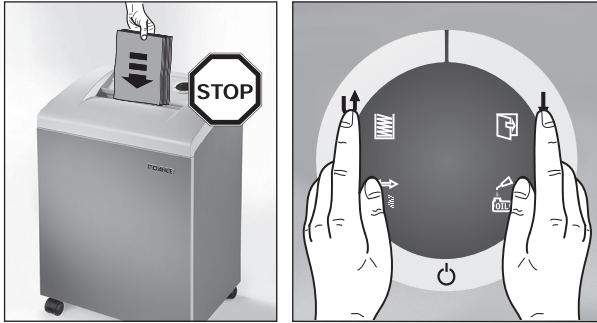

1. En caso de que la cantidad de páginas sea demasiado elevada, el proceso de trituración se detendrá.
2. La barra de corte se mueve de forma independiente un poco hacia atrás y se empuja el papel hacia afuera.
3. **ATENCIÓN:** no accione el interruptor de marcha y de marcha inversa de forma alterna, para que la barra de corte no resulte dañada.

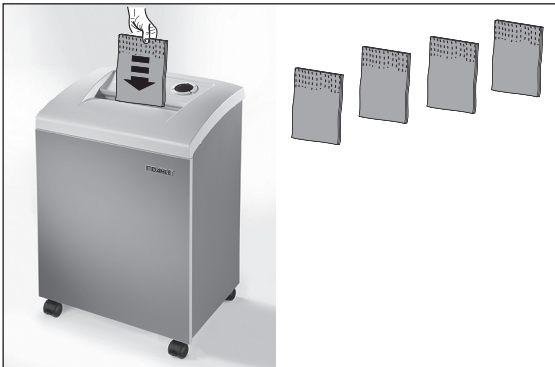

4. En caso de que siga habiendo papel estancado, pulse brevemente el botón de marcha inversa.
5. Reduzca el número de páginas retirándolas o rompiéndolas.
6. Después de volver a introducir papel, el proceso de trituración se inicia automáticamente, de lo contrario, accione el botón de marcha.

#### **706, 710, 710 L plus, 714, 716, 706 air, 710 air, 714 air, 716 air**

1. En caso de que se produzca un atasco de papel, la barra de corte se desplaza a la inversa durante 0,5 segundos.
2. Retire el papel. A continuación, accione el interruptor de marcha para liberar la barra de corte. El interruptor de marcha inversa estará bloqueado hasta que se acciona el interruptor de marcha.
3. Reduzca el número de páginas.



Según la variante del modelo, su destructora no dispondrá de todos los componentes y funciones posibles.

## Modo de ahorro de energía

? 4.



La destructora se desconecta tras un intervalo de inactividad de aprox. 30 minutos (el LED se apaga). Cuando se utiliza, la destructora se enciende con el botón de encendido, de apagado, de parada.





¡Utilice únicamente piezas de repuesto DAHLE!

## Engrasar (solo para corte en partículas P5)



Engrase la barra de corte si el rendimiento del corte disminuye, tras el vaciado del contenedor de papel o a más tardar una vez pasado el tiempo de servicio indicado en la señal de advertencia (**solo para corte en partículas P5**).

1. Conecte la destructora con el botón de encendido, apagado y de parada. Engrase los rodillos de corte manualmente (¡utilice el aceite de destructora DAHLE!).
2. Conecte la trituradora con el botón de encendido, apagado y de parada, deje que la barra de corte funcione a la inversa durante 10 segundos sin alimentación de papel.



1. Apague el interruptor principal y desenchufe el cable de red del enchufe.
2. Limpie el aparato con un paño seco.
3. Conecte el cable de red a un enchufe y encienda el interruptor principal.





**Leggere attentamente il manuale d'uso e le istruzioni di sicurezza prima della messa in servizio del distruggidocumenti! Le istruzioni devono essere seguite! Conservarle per un utilizzo successivo.**

- Conservare, trasportare e utilizzare il distruggidocumenti solo in posizione verticale!
- Sul distruggidocumenti utilizzare solo sostanze liquide o gassose conformi alle direttive DAHLE!
- Utilizzare il distruggidocumenti solo in ambienti chiusi ad una temperatura compresa tra i 15° C e i 32 °C e (59°F - 90°F) e con un'umidità dell'aria senza condensa tra il 15% e il 95%!
- Non posizionare il distruggidocumenti in prossimità di fonti di calore!
- Posizionare il distruggidocumenti in modo stabile sul pavimento e a una distanza di 100 mm dalla parete, azionare i freni di blocco e fissarlo con il set di montaggio eventualmente fornito in dotazione!
- Evitare ristagni di calore! La presa di rete con messa a terra deve essere sempre facilmente accessibile!
- Utilizzare esclusivamente una linea di collegamento alla rete intatta, fornita in dotazione dalla società DAHLE!
- È necessario garantire che l'impianto dell'edificio sia protetto da cortocircuiti: max. 16 A (US massimo 20 A)!
- Non utilizzare in prossimità di liquidi o gas infiammabili!
- Non utilizzare in prossimità di sostanze corrosive!
- Non esporre all'umidità!
- Non aprire l'apparecchio!
- Avvio automatico!
- Non utilizzare il distruggidocumenti a vuoto!
- In caso di non utilizzo spegnere il distruggidocumenti tramite l'interruttore principale!
- Utilizzare il distruggidocumenti esclusivamente in buono stato di manutenzione seguendo le istruzioni per l'uso e nel rispetto delle consuete norme e direttive nonché delle disposizioni sulla sicurezza e sulla prevenzione degli infortuni. In caso di malfunzionamento il distruggidocumenti deve essere immediatamente messo fuori servizio!
- L'apparecchio non deve essere utilizzato da persone (inclusi bambini) con ridotte facoltà fisiche, sensoriali o intellettive o con scarsa esperienza o conoscenze, a meno che queste non siano supervisionate da un responsabile della sicurezza o ricevano dallo stesso istruzioni dettagliate per l'utilizzo dell'apparecchio.



- 1 - Attenersi alle norme di sicurezza!
- 2 - **Prima della messa in servizio del distruggidocumenti leggere attentamente il manuale d'uso e le istruzioni di sicurezza!**
- 3 - Il presente distruggidocumenti non è destinato all'utilizzo da parte di bambini (il prodotto non è un giocattolo)!
- 4 - Non toccare l'alimentatore della carta con le mani!
- 5 - Non toccare l'alimentatore della carta con i vestiti!
- 6 - Non toccare l'alimentatore della carta con i capelli!
- 7 - Prima degli interventi di manutenzione, staccare la presa del distruggidocumenti!
- 8 - In caso di distruzione di CD/DVD è necessario indossare occhiali di protezione!
- 9 - Prima di distruggere i documenti, rimuovere punti e graffette!  
(apparecchi di livello di sicurezza P6 e P7)



## Attenersi agli avvertimenti!



- <sup>1</sup> - Rumorosità in esercizio a vuoto (conformemente a DIN)
- <sup>2</sup> - Distruggidocumenti in standby
- <sup>3</sup> - Distruggidocumenti in esercizio
- <sup>4</sup> - Avvio automatico
- <sup>5</sup> - Lubrificare (utilizzare solo olio DAHLE!)
- <sup>6</sup> - Il distruggidocumenti deve essere smaltito correttamente e in conformità con le norme vigenti in materia di tutela dell'ambiente presso un centro di raccolta autorizzato.  
Non gettare alcun pezzo del distruggidocumenti o dell'imballaggio nei rifiuti domestici.

## Utilizzo conforme, garanzia

Il distruggidocumenti è destinato alla tritatura di carta.

A seconda del modello è inoltre possibile distruggere una piccola quantità dei seguenti materiali:

- CD/DVD, carte assegni e carte di credito (vedi dati tecnici).
- Graffette e punti metallici comunemente utilizzati per fascicolare i documenti di carta (eccezione: apparecchi di livello di sicurezza P6 e P7).

La garanzia non copre l'usura, i danni da utilizzo non conforme nonché gli interventi da parte di terzi.

Il distruggidocumenti è concepito per l'utilizzo privato o per il normale utilizzo d'ufficio.

La portata di fogli riportata nei dati tecnici è soggetta alle seguenti condizioni generali:

Numero massimo di fogli tagliati per volta nelle seguenti condizioni: rulli da taglio nuovi o lubrificati, motore freddo, alimentazione con tensione nominale e frequenza nominale (230V/50Hz; 120V/60Hz). Condizioni diverse da quelle indicate possono comportare una portata di fogli inferiore e un aumento del rumore generato dal dispositivo in funzione. I fogli vanno inseriti al centro e per il lungo con un'inclinazione inferiore a 90°. La portata di fogli può variare a seconda delle proprietà della carta e dell'inserimento.

## Si riserva la facoltà di apportare modifiche tecniche!

## Rimuovere il blocco di sicurezza per il trasporto!



1

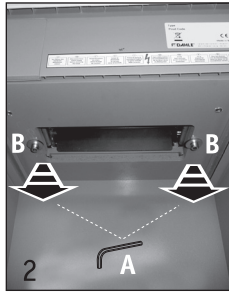

2

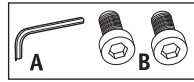

1. Azionare i freni di blocco! Prima della messa in servizio aprire lo sportello e rimuovere il recipiente di raccolta carta.
2. Rimuovere le viti del blocco di sicurezza del trasporto (vano di inserimento del recipiente di raccolta) dalla piastra di fondo situata sotto il meccanismo di taglio, reinserire nuovamente il recipiente di raccolta carta e chiudere lo sportello.
3. Per ogni spostamento di sede è necessario reinserire il blocco di sicurezza per il trasporto.

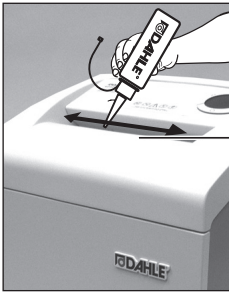

1



2

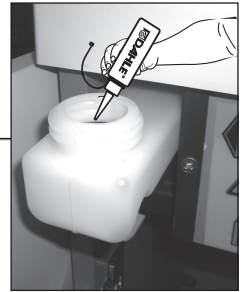

1. Lubrificare i rulli di taglio con olio per distruggidocumenti DAHLE (solo taglio a particelle P5, P6 e P7)!
2. Riempire il serbatoio dell'olio con olio per distruggidocumenti DAHLE!



**A seconda del modello, il distruggidocumenti non comprende tutti i possibili componenti e funzioni.**

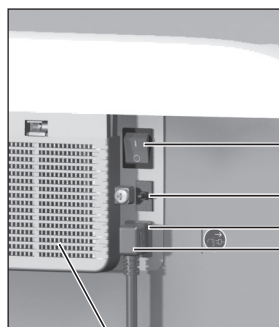
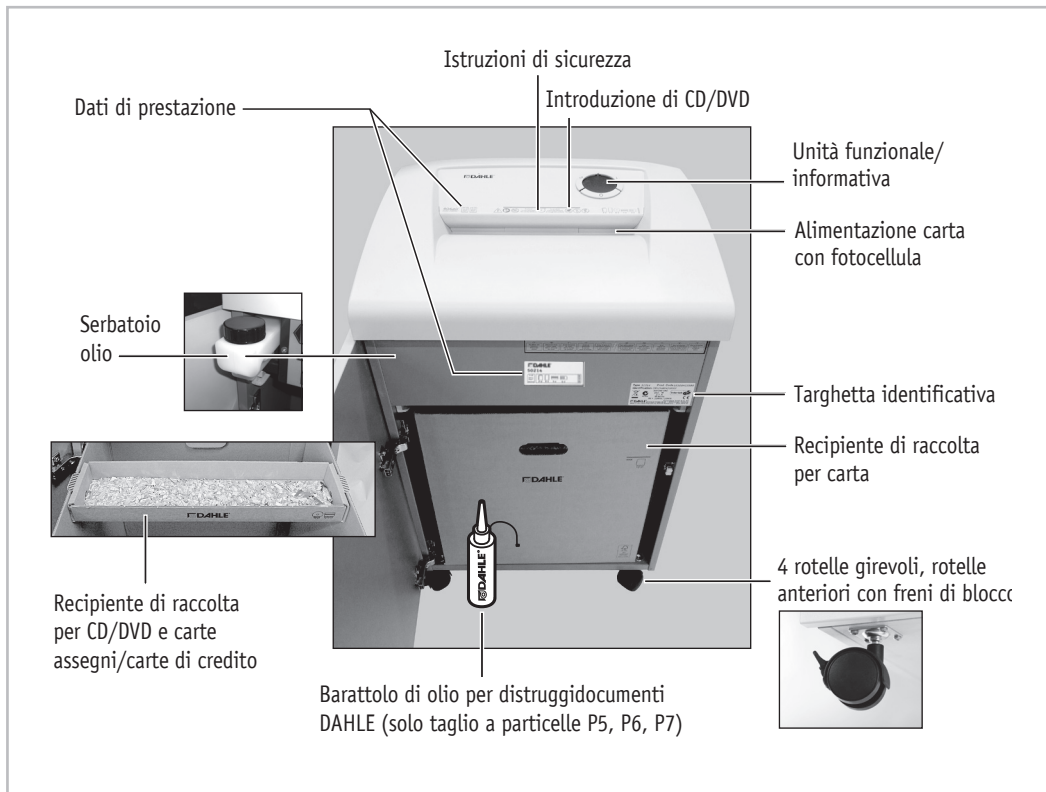

Dopo aver azionato l'interruttore principale attendere 2-3 secondi quindi avviare l'apparecchio premendo il tasto di accensione, spegnimento, arresto.

Interruttore principale

Interruttore magnetotermico di protezione

Presa di collegamento alla rete

Linea di collegamento alla rete

Filtro per particelle fini

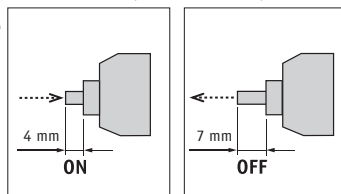



**A seconda del modello, il distruggidocumenti non comprende tutti i possibili componenti e funzioni.**

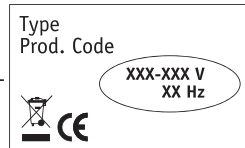
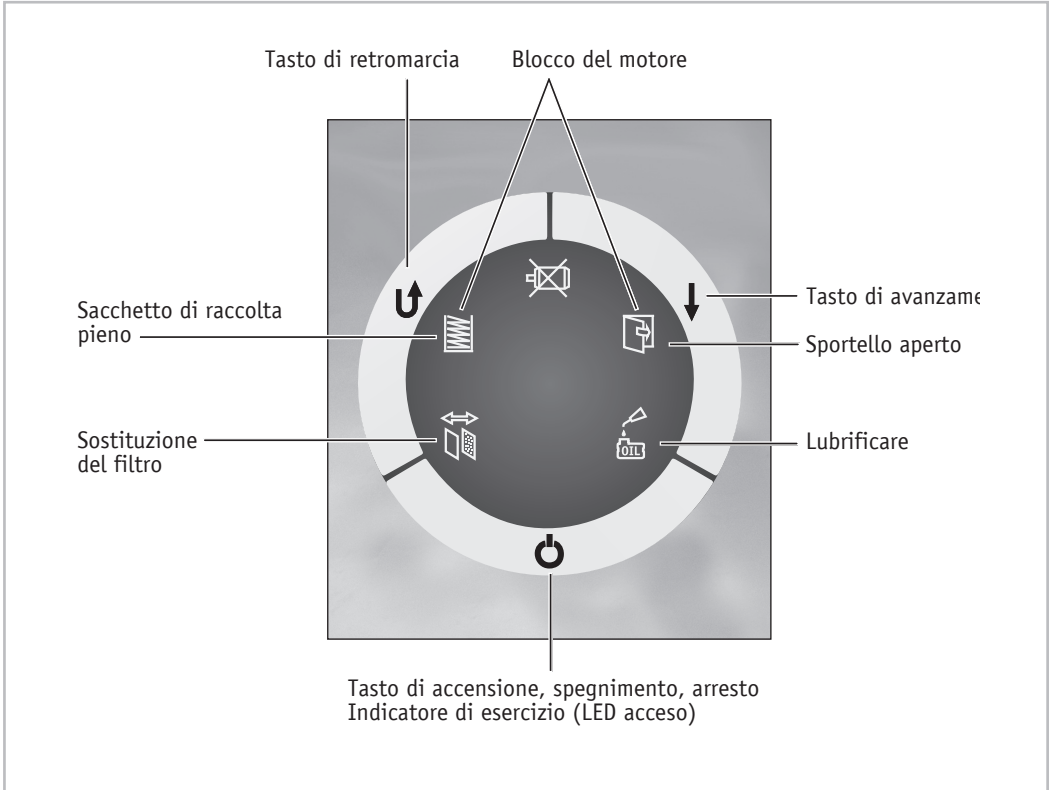





1. Verificare che la tensione e la frequenza di rete siano conformi ai dati riportati sulla targhetta identificativa.











							Livelli di sicurezza conformemente a DIN 66399*				
							P	F	0	T	E
			DIN A4-70g/m <sup>2</sup>	DIN A4-80g/m <sup>2</sup>							
104	40206	240	19	16	5,8mm	-	P-2	-	0-2	T-2	E-2
106	40306	260	27	22	5,8mm	-	P-2	-	0-2	T-2	E-2
110	40406	260	29	23	5,8mm	-	P-2	-	0-2	T-2	E-2
114	40506	310	43	35	5,8mm	-	P-2	-	0-2	T-2	E-2
116	40606	400	45	36	5,8mm	-	P-2	-	0-2	T-2	E-2
104 air	41206	240	19	16	5,8mm	-	P-2	-	0-2	T-2	E-2
106 air	41306	260	27	22	5,8mm	-	P-2	-	0-2	T-2	E-2
110 air	41406	260	29	23	5,8mm	-	P-2	-	0-2	T-2	E-2
114 air	41506	310	43	35	5,8mm	-	P-2	-	0-2	T-2	E-2
116 air	41606	400	45	36	5,8mm	-	P-2	-	0-2	T-2	E-2
203	40104	220	15	13	3,9mm	-	P-2	-	-	T-2	E-2
204	40204	240	17	14	3,9mm	-	P-2	-	-	T-2	E-2
206	40304	260	23	18	3,9mm	-	P-2	-	0-2	T-2	E-2
210	40404	260	24	19	3,9mm	-	P-2	-	0-2	T-2	E-2
214	40504	310	33	26	3,9mm	-	P-2	-	0-2	T-2	E-2
216	40604	400	35	28	3,9mm	-	P-2	-	0-2	T-2	E-2
204 air	41204	240	17	14	3,9mm	-	P-2	-	-	T-2	E-2
206 air	41304	260	23	18	3,9mm	-	P-2	-	0-2	T-2	E-2
210 air	41404	260	24	19	3,9mm	-	P-2	-	0-2	T-2	E-2
214 air	41504	310	33	26	3,9mm	-	P-2	-	0-2	T-2	E-2
216 air	41604	400	35	28	3,9mm	-	P-2	-	0-2	T-2	E-2
306	50310	260	19-21	18-20	-	5,0x50mm	P-3	-	0-3	T-3	E-2
310	50410	260	19-21	18-20	-	5,0x50mm	P-3	-	0-3	T-3	E-2
306 air	51310	260	19-21	18-20	-	5,0x50mm	P-3	-	0-3	T-3	E-2
310 air	51410	260	19-21	18-20	-	5,0x50mm	P-3	-	0-3	T-3	E-2
403	50114	240	8-10	7-9	-	4,0x40,0mm	P-4	F-1	-	T-4	E-3
404	50214	240	8-10	7-9	-	4,0x40,0mm	P-4	F-1	-	T-4	E-3
406	50314	260	17-19	15-17	-	4,0x40,0mm	P-4	F-1	0-3	T-4	E-3
410	50414	260	17-19	15-17	-	4,0x40,0mm	P-4	F-1	0-3	T-4	E-3
410 L plus	50464	310	25-27	24-26	-	4,0x40,0mm	P-4	F-1	0-3	T-4	E-3
414	50514	310	25-27	24-26	-	4,0x40,0mm	P-4	F-1	0-3	T-4	E-3
416	50564	400	19-21	18-20	-	4,0x40,0mm	P-4	F-1	0-3	T-4	E-3
404 air	51214	240	8-10	7-9	-	4,0x40,0mm	P-4	F-1	-	T-4	E-3
406 air	51314	260	17-19	15-17	-	4,0x40,0mm	P-4	F-1	0-3	T-4	E-3
410 air	51414	260	17-19	15-17	-	4,0x40,0mm	P-4	F-1	0-3	T-4	E-3
410 L plus air	51464	310	25-27	24-26	-	4,0x40,0mm	P-4	F-1	0-3	T-4	E-3







































		220-240V 50-60Hz	100-120V 50-60Hz				
	Velocità m/min				Dimensione A x L x P mm	Volume di raccolta l	Peso kg
<=47dB/A	6,0	350W	400W	-	705x430x350	40	25,0
<=47dB/A	4,0	650W	680W	-	865x545x435	60	43,0
<=51dB/A	4,4	650W	680W	-	944x545x435	100	45,0
<=46dB/A	4,5	900W	900W	-	890x734x511	140	64,0
<=50dB/A	6,0	1650W	1650W	-	960x734x511	160	92,0
<=47dB/A	6,0	350W	400W	-	705x430x350	40	26,0
<=47dB/A	4,0	650W	680W	-	865x545x435	60	44,0
<=51dB/A	4,4	650W	680W	-	944x545x435	100	46,0
<=46dB/A	4,5	900W	900W	-	890x734x511	140	65,0
<=50dB/A	6,0	1650W	1650W	-	960x734x511	160	93,0
<=49dB/A	6,0	350W	400W	-	628x430x350	30	22,5
<=46dB/A	6,0	350W	400W	-	705x430x350	40	25,0
<=46dB/A	4,0	650W	680W	-	865x545x435	60	43,0
<=51dB/A	4,4	650W	680W	-	944x545x435	100	45,0
<=47dB/A	4,5	900W	900W	-	890x734x511	140	64,0
<=49dB/A	6,0	1650W	1650W	-	960x734x511	160	92,0
<=46dB/A	6,0	350W	400W	-	705x430x350	40	26,0
<=46dB/A	4,0	650W	680W	-	865x545x435	60	44,0
<=51dB/A	4,4	650W	680W	-	944x545x435	100	46,0
<=47dB/A	4,5	900W	900W	-	890x734x511	140	65,0
<=49dB/A	6,0	1650W	1650W	-	960x734x511	160	93,0
<=46dB/A	4,5	650W	680W	-	865x545x435	60	43,0
<=46dB/A	4,5	650W	680W	-	944x545x435	100	45,0
<=46dB/A	4,5	650W	680W	-	865x545x435	60	43,5
<=46dB/A	4,5	650W	680W	-	944x545x435	100	45,5
<=44dB/A	6,5	350W	400W	-	628x430x350	30	23,0
<=46dB/A	6,5	350W	400W	-	705x430x350	40	25,0
<=46dB/A	4,5	650W	680W	-	865x545x435	60	43,0
<=52dB/A	4,5	650W	680W	-	944x545x435	100	45,0
<=52dB/A	4,7	900W	900W	-	944x545x435	100	54,5
<=52dB/A	4,7	900W	900W	-	890x734x511	140	64,0
<=52dB/A	5,7	900W	900W	-	960x734x511	160	68,5
<=46dB/A	6,5	350W	400W	-	705x430x350	40	25,5
<=46dB/A	4,5	650W	680W	-	865x545x435	60	43,5
<=52dB/A	4,5	650W	680W	-	944x545x435	100	45,5
<=52dB/A	4,7	900W	900W	-	944x545x435	100	55,0



		Livelli di sicurezza conformemente a DIN 66399*									
							P	F	0	T	E
			<b>DIN A4-70g/m<sup>2</sup></b>	<b>DIN A4-80g/m<sup>2</sup></b>							
414 air	51514	310	25-27	24-26	-	4,0x40,0mm	P-4	F-1	0-3	T-4	E-3
416 air	51564	400	19-21	18-20	-	4,0x40,0mm	P-4	F-1	0-3	T-4	E-3
504	40222	240	6	5	-	2,0x15,0mm	P-5	F-2	-	T-5	E-4
506	50322	260	12-14	11-13	-	2,0x15,0mm	P-5	F-2	-	T-5	E-4
510	50422	260	12-14	11-13	-	2,0x15,0mm	P-5	F-2	-	T-5	E-4
510 L plus	50472	310	18-20	17-19	-	2,0x15,0mm	P-5	F-2	0-4	T-5	E-4
514	50522	310	18-20	17-19	-	2,0x15,0mm	P-5	F-2	0-4	T-5	E-4
516	50572	400	14-16	13-15	-	2,0x15,0mm	P-5	F-2	0-4	T-5	E-4
504 air	41222	240	6	5	-	2,0x15,0mm	P-5	F-2	-	T-5	E-4
506 air	51322	260	12-14	11-13	-	2,0x15,0mm	P-5	F-2	-	T-5	E-4
510 air	51422	260	12-14	11-13	-	2,0x15,0mm	P-5	F-2	-	T-5	E-4
510 L plus air	51472	310	18-20	17-19	-	2,0x15,0mm	P-5	F-2	0-4	T-5	E-4
514 air	51522	310	18-20	17-19	-	2,0x15,0mm	P-5	F-2	0-4	T-5	E-4
516 air	51572	400	14-16	13-15	-	2,0x15,0mm	P-5	F-2	0-4	T-5	E-4
604	40230	240	3	2	-	0,8x12,0mm	P-6	F-3	-	-	-
606	40330	260	6	5	-	0,8x12,0mm	P-6	F-3	-	T-6	-
610	40430	260	7	6	-	0,8x12,0mm	P-6	F-3	-	T-6	-
614	40530	310	11	9	-	0,8x12,0mm	P-6	F-3	-	T-6	-
616	40630	400	14	11	-	0,8x12,0mm	P-6	F-3	-	T-6	-
604 air	41230	240	3	2	-	0,8x12,0mm	P-6	F-3	-	-	-
606 air	41330	260	6	5	-	0,8x12,0mm	P-6	F-3	-	T-6	-
610 air	41430	260	7	6	-	0,8x12,0mm	P-6	F-3	-	T-6	-
614 air	41530	310	11	9	-	0,8x12,0mm	P-6	F-3	-	T-6	-
616 air	41630	400	14	11	-	0,8x12,0mm	P-6	F-3	-	T-6	-
706	40334	260	6	5	-	1,0x4,7mm	P-7	F-3	-	T-6	-
710	40434	260	6	5	-	1,0x4,7mm	P-7	F-3	-	T-6	-
710 L plus	40484	310	9	7	-	1,0x4,7mm	P-7	F-3	-	T-6	-
714	40534	310	9	7	-	1,0x4,7mm	P-7	F-3	-	T-6	-
716	40634	400	12	9	-	1,0x4,7mm	P-7	F-3	-	T-6	-
706 air	41334	260	6	5	-	1,0x4,7mm	P-7	F-3	-	T-6	-
710 air	41434	260	6	5	-	1,0x4,7mm	P-7	F-3	-	T-6	-
714 air	41534	310	9	7	-	1,0x4,7mm	P-7	F-3	-	T-6	-
716 air	41634	400	12	9	-	1,0x4,7mm	P-7	F-3	-	T-6	-



		220-240V 50-60Hz	100-120V 50-60Hz				
	Velocità m/min				Dimensione A x L x P mm	Volume di raccolta l	Peso kg
≤52dB/A	4,7	900W	900W	-	890x734x511	140	64,5
≤52dB/A	5,7	900W	900W	-	960x734x511	160	69,0
≤47dB/A	6,0	350W	400W		705x430x350	40	25,0
≤46dB/A	4,4	650W	680W		865x545x435	60	44,0
≤53dB/A	4,4	650W	680W		944x545x435	100	46,0
≤53dB/A	4,8	900W	900W		944x545x435	100	59,0
≤52dB/A	4,8	900W	900W		890x734x511	140	68,5
≤53dB/A	5,6	900W	900W		960x734x511	160	75,0
≤47dB/A	6,0	350W	400W		705x430x350	40	26,0
≤46dB/A	4,4	650W	680W		865x545x435	60	43,0
≤53dB/A	4,4	650W	680W		944x545x435	100	47,0
≤53dB/A	4,8	900W	900W		944x545x435	100	60,0
≤53dB/A	4,8	900W	900W		890x734x511	140	69,5
≤53dB/A	5,6	900W	900W		960x734x511	160	76,0
≤50dB/A	6,0	350W	400W		705x430x350	40	25,0
≤47dB/A	3,5	650W	680W		865x545x435	60	43,0
≤52dB/A	4,3	650W	680W		944x545x435	100	45,0
≤50dB/A	4,5	900W	900W		890x734x511	140	64,0
≤50dB/A	4,0	1650W	1650W		960x734x511	160	92,0
≤50dB/A	6,0	350W	400W		705x430x350	40	26,0
≤47dB/A	3,5	650W	680W		865x545x435	60	44,0
≤52dB/A	4,3	650W	680W		944x545x435	100	46,0
≤50dB/A	4,5	900W	900W		890x734x511	140	65,0
≤50dB/A	4,0	1650W	1650W		960x734x511	160	93,0
≤50dB/A	6,5	650W	680W		865x545x435	60	43,0
≤52dB/A	6,5	650W	680W		944x545x435	100	45,0
≤52dB/A	7,0	900W	900W		944x545x435	100	60,0
≤52dB/A	7,0	900W	900W		890x734x511	140	64,0
≤52dB/A	8,0	1650W	1650W		960x734x511	160	92,0
≤50dB/A	6,5	650W	680W		865x545x435	60	44,0
≤52dB/A	6,5	650W	680W		944x545x435	100	46,0
≤52dB/A	7,0	900W	900W		890x734x511	140	65,0
≤52dB/A	8,0	1650W	1650W		960x734x511	160	93,0

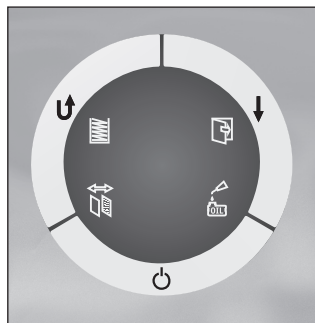

### Si prega di attenersi alle istruzioni di sicurezza.

1. Prima dell'utilizzo del distruggidocumenti, verificare la posizione del recipiente di raccolta per CD/DVD e carte assegni/carte di credito. In caso di distruzione di carta, questo deve trovarsi nell'area anteriore del recipiente di raccolta per carta.
2. Chiudere lo sportello del distruggidocumenti.
3. Collegare la linea di rete fornita in dotazione con il distruggidocumenti e con una presa di rete. Accendere l'interruttore principale e attendere 2-3 secondi.
4. Accendere il distruggidocumenti azionando il tasto di accensione, spegnimento, arresto.

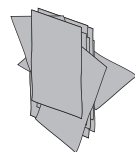

O.K.



1. **Attenersi alle indicazioni relative al numero di fogli massimo, riportate nei Dati tecnici!**
2. Inserire la carta al centro dell'alimentazione carta, la fotocellula integrata avvia automaticamente il distruggidocumenti.
3. Quando l'alimentatore della carta è di nuovo libero, il distruggidocumenti si disattiva automaticamente e passa allo stato di standby.
4. Avanzamento permanente: se il tasto di avanzamento viene premuto per un periodo di tempo prolungato (circa 5 secondi), il distruggidocumenti passa in modalità di avanzamento permanente.
5. Se l'alimentazione della carta viene interrotta per 15 secondi, l'avanzamento permanente si disattiva.



A seconda del modello, il distruggidocumenti non comprende tutti i possibili componenti e funzioni.

2.

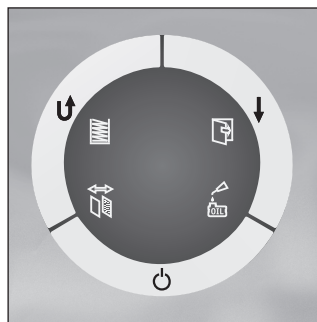
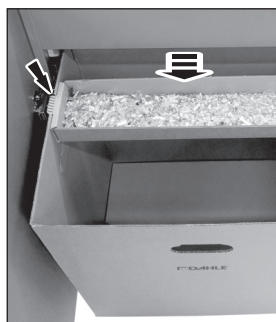

**Si prega di attenersi alle istruzioni di sicurezza: in caso di distruzione di CD/DVD è necessario indossare occhiali di protezione!**

1. Prima dell'utilizzo del distruggidocumenti, verificare la posizione del recipiente di raccolta per CD/DVD e carte assegni/carte di credito. In caso di distruzione di CD/DVD e carte assegni/carte di credito, questo deve trovarsi nell'area posteriore del recipiente di raccolta per la carta.
2. Estrarre il recipiente di raccolta e posizionare il recipiente di raccolta per CD/DVD e carte di credito/carte assegni nella zona posteriore.
3. Chiudere lo sportello del distruggidocumenti.
4. Accendere il distruggidocumenti azionando il tasto di accensione, spegnimento, arresto.

2.1



1. Inserire i CD/DVD o le carte assegni/carte di credito al centro dell'alimentatore e tenere premuto il tasto di avanzamento.
2. Quando l'alimentatore del CD/DVD è di nuovo libero, il distruggidocumenti si disattiva automaticamente e passa allo stato di standby.



A seconda del modello, il distruggidocumenti non comprende tutti i possibili componenti e funzioni.

## DAHLE CleanTEC®

### Cambiare il filtro per particelle fini

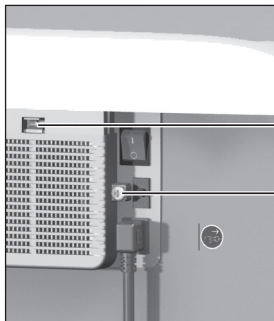
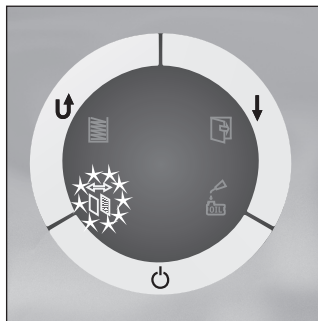

Blocco

Vite

1. Il segnale di cambio del filtro (**cambiare il filtro per particelle fini DAHLE!**) si accende nel campo di comando.
2. Staccare la linea di collegamento di rete dalla presa.
3. Sostituire il filtro per particelle fini sul lato posteriore dell'apparecchio.
  - A. Allentare le viti
  - B. Premere il blocco e togliere il coperchio.
  - C. Estrarre il filtro e smaltirlo. Non dimenticare di reinserire il **filtro per polveri fini DAHLE!**
  - D. Chiudere il coperchio
  - E. Serrare la vite
4. Collegare la linea di collegamento di rete alla presa, accendere l'interruttore principale e premere il tasto di accensione, spegnimento, arresto.
5. Resetare l'indicatore di sostituzione del filtro: tenere premuto il tasto di avanzamento e retromarcia per circa 5 secondi.

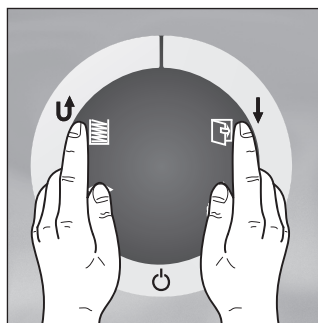

**Non si assume alcuna responsabilità per l'utilizzo improprio o la mancata sostituzione del filtro per polveri fini DAHLE.**

**Il filtro per polveri fini DAHLE usato può essere smaltito nei normali rifiuti domestici.**

**Le particelle fini sono integrate all'interno del filtro DAHLE per polveri fini.**

**Smaltire il filtro DAHLE per polveri fini assicurandosi che sia lontano dalla portata dei bambini.**



A seconda del modello, il distruggidocumenti non comprende tutti i possibili componenti e funzioni.

## Lubrificazione automatica (solo taglio a particelle P5, P6 e P7)

Riempire il serbatoio dell'olio con olio per distruggidocumenti DAHLE.

Serbatoio dell'olio integrato per una lubrificazione dei rulli regolata e automatica.

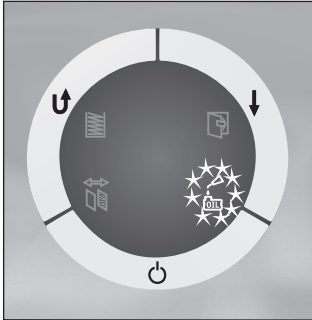

Riempire il serbatoio dell'olio integrato nel distruggidocumenti quando si accende il corrispondente segnale sul display.

1. Accendere il distruggidocumenti azionando l'interruttore di accensione, spegnimento, arresto.
2. Aprire lo sportello. Il serbatoio dell'olio integrato è collocato nell'armadio, aprire il tappo di chiusura.
3. Riempire il serbatoio dell'olio (con olio per distruggidocumenti DAHLE!) e richiudere.



A seconda del modello, il distruggidocumenti non comprende tutti i possibili componenti e funzioni.

Recipiente di raccolta pieno: Il LED lampeggia.

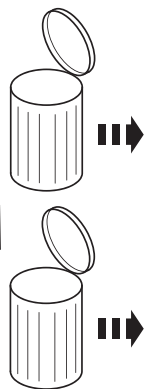
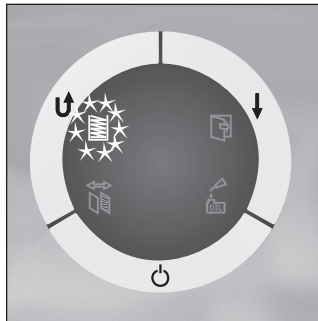

1. Quando il recipiente di raccolta è pieno, il processo di taglio viene bloccato e lo stato viene segnalato visivamente.
2. Spegnerne l'interruttore principale e staccare dalla presa la linea di collegamento alla rete.
3. Estrarre il recipiente di raccolta, svuotarlo e inserirlo.
4. Collegare la linea di rete con la presa e accendere l'interruttore principale.





**A seconda del modello, il distruggidocumenti non comprende tutti i possibili componenti e funzioni.**

**Spegnimento automatico del motore:** I LED del livello di riempimento e dello sportello lampeggiano.

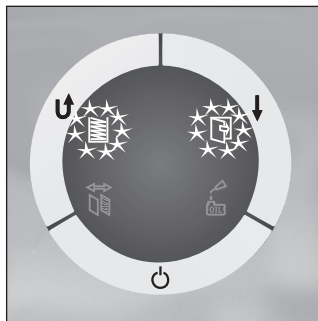

1. Spegnimento automatico del motore in caso di:
  - surriscaldamento del motore
  - inceppamento carta

**Sportello aperto:** Il LED lampeggia.

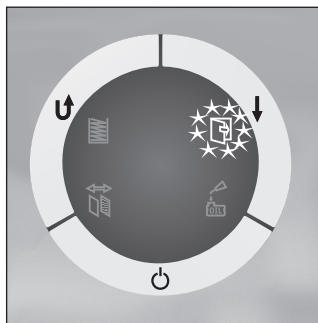

1. Se lo sportello è aperto, il processo di taglio viene bloccato e il LED lampeggia. Chiudere lo sportello.

A seconda del modello, il distruggidocumenti non comprende tutti i possibili componenti e funzioni.

? 1.

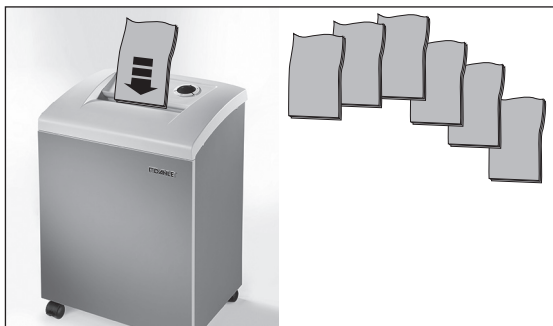

Dopo un periodo di esercizio prolungato e/o un sovraccarico il distruggidocumenti si spegne automaticamente per garantirne il raffreddamento.

? 2.



Interruttore magnetotermico di protezione

### Il processo di taglio non viene avviato:

- Linea di collegamento alla rete non collegata con la presa di rete?
- Sportello aperto?
- Interruttore principale non acceso?
- Recipiente di raccolta pieno?
- Tasto di accensione, spegnimento, arresto non inserito?
- Apparecchio sovraccarico/surriscaldato?
- Interruttore magnetotermico di protezione su OFF?

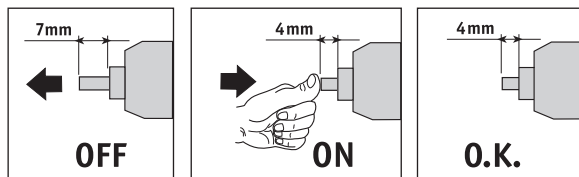

Spostare l'interruttore magnetotermico di protezione nella posizione corretta (ON).

A seconda del modello, il distruggidocumenti non comprende tutti i possibili componenti e funzioni.

? 3.

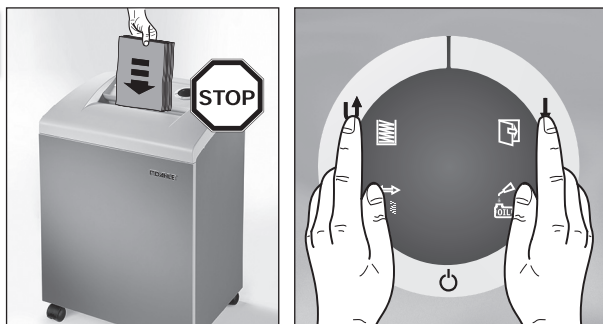

1. Se il numero di fogli inseriti è eccessivo, il processo di taglio viene bloccato.
2. Il meccanismo di taglio si muove autonomamente all'indietro e la carta viene espulsa.
3. **ATTENZIONE, non azionare in modo alternato l'interruttore di avanzamento e di retromarcia per non danneggiare il meccanismo di taglio!**

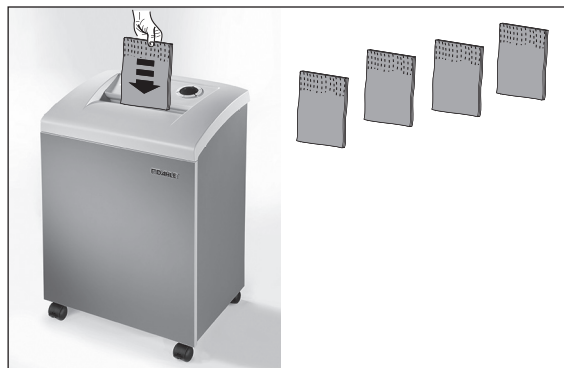

4. Se la carta continua a essere inceppata, premere brevemente il tasto di retromarcia.
5. Ridurre il numero di fogli, estraendone alcuni o strappando quelli inceppati.
6. Dopo aver nuovamente introdotto la carta il processo di taglio si avvia automaticamente, in caso contrario azionare il tasto di avanzamento.

#### 706, 710, 710 L plus, 714, 716, 706 air, 710 air, 714 air, 716 air

1. In caso di inceppamento, il meccanismo di taglio si muova in senso contrario per 0,5 secondi.
2. Estrarre la carta. Azionare quindi l'interruttore di avanzamento per liberare il meccanismo di taglio. L'interruttore di retromarcia resta bloccato fino all'azionamento dell'interruttore di avanzamento.
3. Ridurre il numero di fogli.

A seconda del modello, il distruggidocumenti non comprende tutti i possibili componenti e funzioni.

## Modalità di risparmio energetico

?

4.



In caso di non utilizzo, dopo circa 30 minuti il distruggidocumenti si spegne (LED spento). Durante l'uso il distruggidocumenti si accende tramite il tasto di accensione, spegnimento, arresto.



Utilizzare esclusivamente pezzi di ricambio DAHLE!

## Lubrificazione (taglio a particelle P5)



Lubrificare il meccanismo di taglio in caso di calo della potenza di taglio, in seguito a ogni svuotamento del recipiente di raccolta o al più tardi allo scadere del termo di esercizio indicato nell'avvertenza (**solo per taglio a particelle P5**).

1. Accendere il distruggidocumenti azionando l'interruttore di accensione, spegnimento, arresto. Lubrificare manualmente i rulli di taglio (utilizzare olio per distruggidocumenti DAHLE!).
2. Accendere il distruggidocumenti azionando l'interruttore di accensione, spegnimento, arresto e far scorrere all'indietro l'alimentazione della carta per 10 secondi.

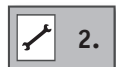

1. Spegnere il distruggidocumenti e staccare dalla presa la linea di collegamento alla rete.
2. Pulire l'apparecchio solo con un panno asciutto.
3. Collegare la linea di rete con la presa ed accendere il distruggidocumenti.





**Antes da colocação em funcionamento da trituradora de papel, ler cuidadosamente o manual de utilização e as indicações de segurança! As indicações devem ser respeitadas! Guarde-as para uso futuro.**

- Armazenar, transportar ou utilizar exclusivamente a trituradora de papel na vertical!
- Utilizar na trituradora de papel apenas líquidos e gases que correspondam às diretivas DAHLE!
- A trituradora de papel deve ser utilizada em espaços fechados, a uma temperatura entre os 15 °C e os 32 °C (59 °F–90 °F) e uma humidade atmosférica não condensada de 15% a 95%!
- A trituradora de papel não pode ser colocada junto de uma fonte de calor!
- Colocar a trituradora de papel de forma segura no solo e a uma distância de 100 mm da parede, acionar os travões e fixar com o conjunto de montagem eventualmente fornecido!
- Evitar acumulação de calor!
- A tomada de rede com ligação à terra deve estar sempre acessível!
- Utilizar apenas um cabo de ligação de rede não danificado fornecido pela empresa DAHLE!
- Providenciar a proteção contra curto-circuito na instalação do edifício: máx. 16 A (EUA: máx. 20 A)!
- Não utilizar junto de líquidos e gases inflamáveis!
- Não utilizar junto de materiais ácidos!
- Não expor à humidade!
- Não abrir o aparelho!
- Iniciação automática!
- Não utilizar a trituradora de papel em vazio!
- Quando não estiver a ser utilizada, desligar a trituradora de papel no interruptor principal!
- Utilizar a trituradora de papel apenas se estiver em perfeito estado de funcionamento, respeitando o manual de utilização, os regulamentos e normas habituais, bem como as regras de segurança e instruções relativas à prevenção de acidentes aplicáveis. Se ocorrerem avarias, a trituradora de papel deve ser colocada imediatamente fora de serviço!
- Este aparelho não é indicado para utilização por pessoas (incluindo crianças) com capacidades físicas, sensoriais ou mentais reduzidas ou com pouca experiência e conhecimento, exceto se forem supervisionadas durante o trabalho ou receberem instruções relativamente à utilização do aparelho por uma pessoa responsável pela sua segurança.



- 1 - É necessário aplicar as regulamentações de segurança!
- 2 - **Antes da colocação em funcionamento da trituradora de papel, ler cuidadosamente o manual de utilização e as indicações de segurança!**
- 3 - Esta trituradora de papel não está equipada para ser utilizada por crianças (o produto não é nenhum brinquedo)!
- 4 - Não toque com as mãos na alimentação do papel!
- 5 - Não toque com a roupa na alimentação do papel!
- 6 - Não toque com o cabelo na alimentação do papel!
- 7 - Antes dos trabalhos de manutenção desligar a trituradora de papel da rede!
- 8 - Utilizar óculos de proteção para triturar CD/DVD!
- 9 - Remover agrafos e cliques antes do processo de trituração!  
(aparelhos com nível de segurança P6 e P7)



## Observar indicações de aviso!



- 1 - Volume de funcionamento em vazio (conforme DIN)
- 2 - Trituradora de papel operacional
- 3 - Trituradora de papel em funcionamento
- 4 - Iniciação automática
- 5 - Lubrificar (apenas utilizar óleo DAHLE!)
- 6 - Elimine a trituradora de papel de forma compatível com o meio ambiente num ponto de recolha autorizado. Não coloque nenhuma peça da trituradora de papel ou a embalagem no lixo doméstico

## Utilização correta, garantia

A trituradora de papel destina-se à trituração de papel.

Conforme a variante do modelo podem ser eliminados os seguintes materiais em quantidades reduzidas:

- CD/DVD, cartões de crédito e de cheque (ver dados técnicos)
- cliques e agramos que estejam presentes, em quantidades normais, nos documentos de papel (exceção: aparelhos com nível de segurança P6 e P7)

Desgaste, danos provocados por uma utilização incorreta, assim como intervenções de terceiros não estão abrangidos pela garantia, nem o fabricante assume qualquer responsabilidade pelos mesmos.

A trituradora de papel foi concebida para uso doméstico e para o funcionamento num ambiente de escritório normal.

No que se refere ao desempenho das folhas indicado nos dados técnicos, aplicam-se as seguintes condições básicas:

Número máximo de folhas cortadas de uma só vez, segundo as seguintes condições de funcionamento: Rolamentos de corte novos ou possivelmente oleados, motor frio, fonte de alimentação com tensão nominal e frequência nominal (230 V/50 Hz; 120 V/60 Hz). O não cumprimento destas condições de funcionamento pode levar ao desempenho reduzido da lâmina e ao aumento de ruídos de funcionamento. As folhas devem ser introduzidas centralmente e longitudinalmente a 90°. As propriedades do papel e da sua forma de introdução também podem alterar o desempenho das folhas.

## Reserva-se o direito a alterações técnicas!

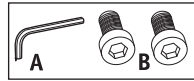
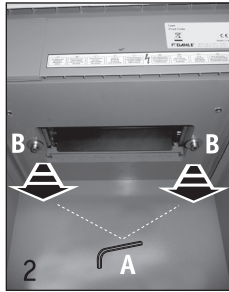

**Remover proteção de transporte!**

1. Acionar travões! Abrir a porta antes da primeira colocação em funcionamento, remover recipiente de recolha do papel.
2. Remover os parafusos da proteção de transporte (área de introdução do recipiente de recolha do papel) da placa do solo por baixo do dispositivo de corte, introduzir novamente o recipiente de recolha do papel e fechar a porta.
3. Em cada mudança de local deve-se colocar novamente a proteção de transporte.

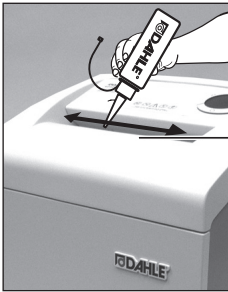

1



2

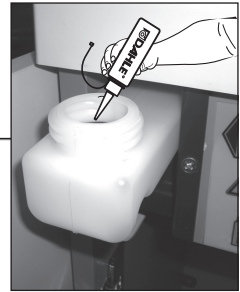

1. Lubrificar os rolos de corte com o óleo da tritadora de papel DAHLE (apenas corte de partículas P5, P6 e P7)!
2. Abastecer o depósito de óleo com o óleo da tritadora de papel DAHLE!



Conforme a variante do modelo a sua trituradora de papel não possui todos os componentes nem todas as funções possíveis.

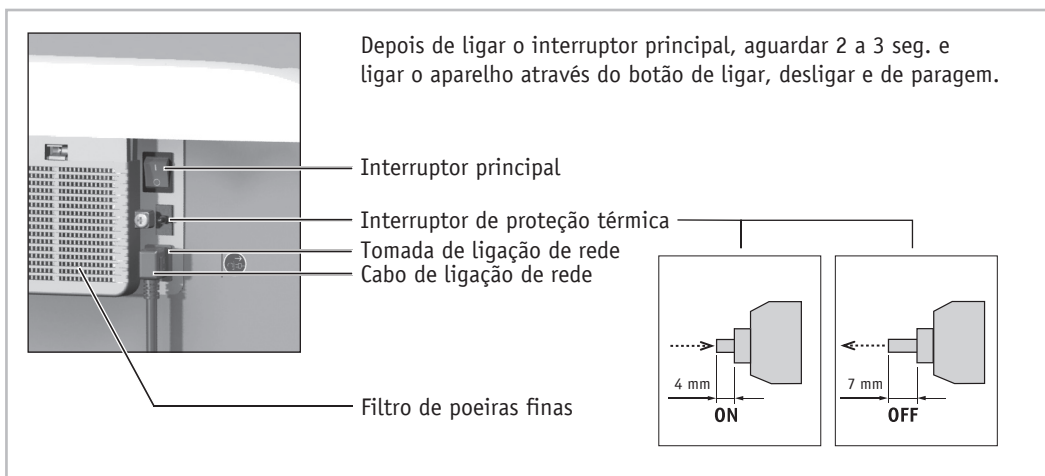
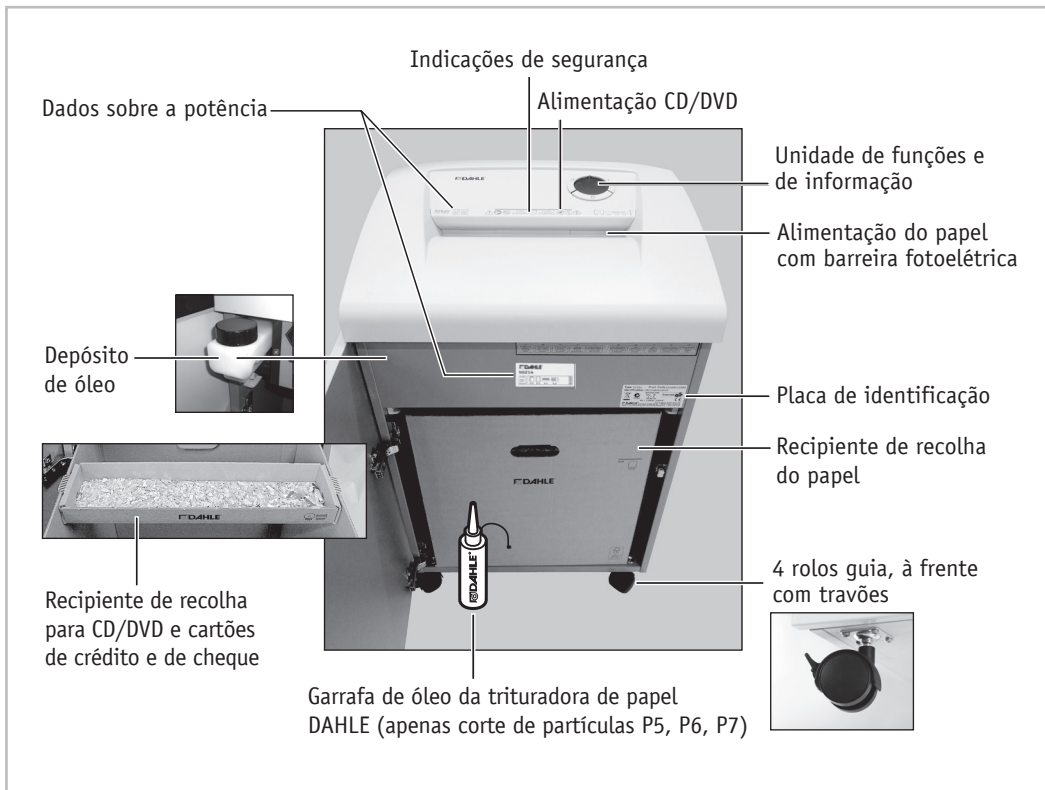



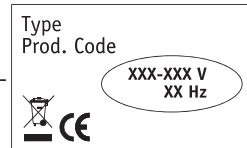
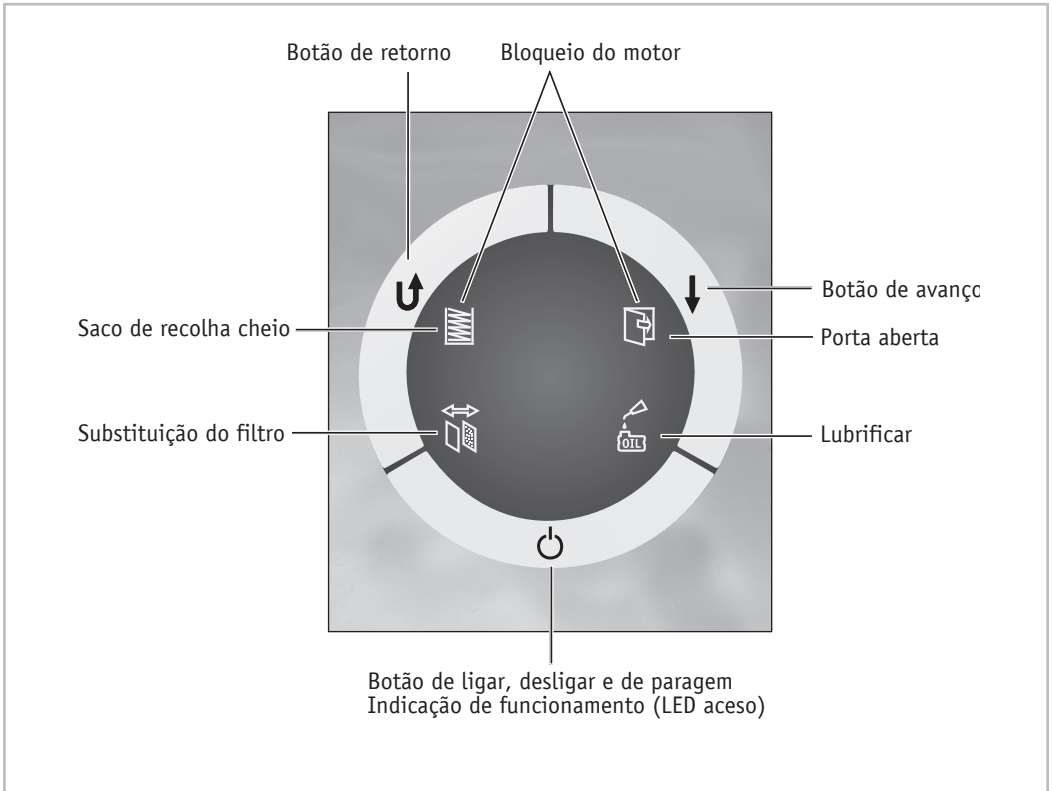





Conforme a variante do modelo a sua trituradora de papel não possui todos os componentes nem todas as funções possíveis.







1. Verificar se a tensão e a frequência de rede da sua rede de corrente correspondem às indicações da placa de identificação.











							Níveis de segurança conforme DIN 66399*				
							P	F	0	T	E
			DIN A4- 70g/m <sup>2</sup>	DIN A4- 80g/m <sup>2</sup>							
104	40206	240	19	16	5,8mm	-	P-2	-	0-2	T-2	E-2
106	40306	260	27	22	5,8mm	-	P-2	-	0-2	T-2	E-2
110	40406	260	29	23	5,8mm	-	P-2	-	0-2	T-2	E-2
114	40506	310	43	35	5,8mm	-	P-2	-	0-2	T-2	E-2
116	40606	400	45	36	5,8mm	-	P-2	-	0-2	T-2	E-2
104 air	41206	240	19	16	5,8mm	-	P-2	-	0-2	T-2	E-2
106 air	41306	260	27	22	5,8mm	-	P-2	-	0-2	T-2	E-2
110 air	41406	260	29	23	5,8mm	-	P-2	-	0-2	T-2	E-2
114 air	41506	310	43	35	5,8mm	-	P-2	-	0-2	T-2	E-2
116 air	41606	400	45	36	5,8mm	-	P-2	-	0-2	T-2	E-2
203	40104	220	15	13	3,9mm	-	P-2	-	-	T-2	E-2
204	40204	240	17	14	3,9mm	-	P-2	-	-	T-2	E-2
206	40304	260	23	18	3,9mm	-	P-2	-	0-2	T-2	E-2
210	40404	260	24	19	3,9mm	-	P-2	-	0-2	T-2	E-2
214	40504	310	33	26	3,9mm	-	P-2	-	0-2	T-2	E-2
216	40604	400	35	28	3,9mm	-	P-2	-	0-2	T-2	E-2
204 air	41204	240	17	14	3,9mm	-	P-2	-	-	T-2	E-2
206 air	41304	260	23	18	3,9mm	-	P-2	-	0-2	T-2	E-2
210 air	41404	260	24	19	3,9mm	-	P-2	-	0-2	T-2	E-2
214 air	41504	310	33	26	3,9mm	-	P-2	-	0-2	T-2	E-2
216 air	41604	400	35	28	3,9mm	-	P-2	-	0-2	T-2	E-2
306	50310	260	19-21	18-20	-	5,0x50mm	P-3	-	0-3	T-3	E-2
310	50410	260	19-21	18-20	-	5,0x50mm	P-3	-	0-3	T-3	E-2
306 air	51310	260	19-21	18-20	-	5,0x50mm	P-3	-	0-3	T-3	E-2
310 air	51410	260	19-21	18-20	-	5,0x50mm	P-3	-	0-3	T-3	E-2
403	50114	240	8-10	7-9	-	4,0x40,0mm	P-4	F-1	-	T-4	E-3
404	50214	240	8-10	7-9	-	4,0x40,0mm	P-4	F-1	-	T-4	E-3
406	50314	260	17-19	15-17	-	4,0x40,0mm	P-4	F-1	0-3	T-4	E-3
410	50414	260	17-19	15-17	-	4,0x40,0mm	P-4	F-1	0-3	T-4	E-3
410 L plus	50464	310	25-27	24-26	-	4,0x40,0mm	P-4	F-1	0-3	T-4	E-3
414	50514	310	25-27	24-26	-	4,0x40,0mm	P-4	F-1	0-3	T-4	E-3
416	50564	400	19-21	18-20	-	4,0x40,0mm	P-4	F-1	0-3	T-4	E-3
404 air	51214	240	8-10	7-9	-	4,0x40,0mm	P-4	F-1	-	T-4	E-3
406 air	51314	260	17-19	15-17	-	4,0x40,0mm	P-4	F-1	0-3	T-4	E-3
410 air	51414	260	17-19	15-17	-	4,0x40,0mm	P-4	F-1	0-3	T-4	E-3
410 L plus air	51464	310	25-27	24-26	-	4,0x40,0mm	P-4	F-1	0-3	T-4	E-3





































		220-240V 50-60Hz	100-120V 50-60Hz				
	Velocidade m/min				Dimensões A x L x P mm	Volume de recolha I	Peso kg
<=47dB/A	6,0	350W	400W	-	705x430x350	40	25,0
<=47dB/A	4,0	650W	680W	-	865x545x435	60	43,0
<=51dB/A	4,4	650W	680W	-	944x545x435	100	45,0
<=46dB/A	4,5	900W	900W	-	890x734x511	140	64,0
<=50dB/A	6,0	1650W	1650W	-	960x734x511	160	92,0
<=47dB/A	6,0	350W	400W	-	705x430x350	40	26,0
<=47dB/A	4,0	650W	680W	-	865x545x435	60	44,0
<=51dB/A	4,4	650W	680W	-	944x545x435	100	46,0
<=46dB/A	4,5	900W	900W	-	890x734x511	140	65,0
<=50dB/A	6,0	1650W	1650W	-	960x734x511	160	93,0
<=49dB/A	6,0	350W	400W	-	628x430x350	30	22,5
<=46dB/A	6,0	350W	400W	-	705x430x350	40	25,0
<=46dB/A	4,0	650W	680W	-	865x545x435	60	43,0
<=51dB/A	4,4	650W	680W	-	944x545x435	100	45,0
<=47dB/A	4,5	900W	900W	-	890x734x511	140	64,0
<=49dB/A	6,0	1650W	1650W	-	960x734x511	160	92,0
<=46dB/A	6,0	350W	400W	-	705x430x350	40	26,0
<=46dB/A	4,0	650W	680W	-	865x545x435	60	44,0
<=51dB/A	4,4	650W	680W	-	944x545x435	100	46,0
<=47dB/A	4,5	900W	900W	-	890x734x511	140	65,0
<=49dB/A	6,0	1650W	1650W	-	960x734x511	160	93,0
<=46dB/A	4,5	650W	680W	-	865x545x435	60	43,0
<=46dB/A	4,5	650W	680W	-	944x545x435	100	45,0
<=46dB/A	4,5	650W	680W	-	865x545x435	60	43,5
<=46dB/A	4,5	650W	680W	-	944x545x435	100	45,5
<=44dB/A	6,5	350W	400W	-	628x430x350	30	23,0
<=46dB/A	6,5	350W	400W	-	705x430x350	40	25,0
<=46dB/A	4,5	650W	680W	-	865x545x435	60	43,0
<=52dB/A	4,5	650W	680W	-	944x545x435	100	45,0
<=52dB/A	4,7	900W	900W	-	944x545x435	100	54,5
<=52dB/A	4,7	900W	900W	-	890x734x511	140	64,0
<=52dB/A	5,7	900W	900W	-	960x734x511	160	68,5
<=46dB/A	6,5	350W	400W	-	705x430x350	40	25,5
<=46dB/A	4,5	650W	680W	-	865x545x435	60	43,5
<=52dB/A	4,5	650W	680W	-	944x545x435	100	45,5
<=52dB/A	4,7	900W	900W	-	944x545x435	100	55,0



		Níveis de segurança conforme DIN 66399*									
							P	F	0	T	E
			DIN A4-70g/m <sup>2</sup>	DIN A4-80g/m <sup>2</sup>							
414 air	51514	310	25-27	24-26	-	4,0x40,0mm	P-4	F-1	0-3	T-4	E-3
416 air	51564	400	19-21	18-20	-	4,0x40,0mm	P-4	F-1	0-3	T-4	E-3
504	40222	240	6	5	-	2,0x15,0mm	P-5	F-2	-	T-5	E-4
506	50322	260	12-14	11-13	-	2,0x15,0mm	P-5	F-2	-	T-5	E-4
510	50422	260	12-14	11-13	-	2,0x15,0mm	P-5	F-2	-	T-5	E-4
510 L plus	50472	310	18-20	17-19	-	2,0x15,0mm	P-5	F-2	0-4	T-5	E-4
514	50522	310	18-20	17-19	-	2,0x15,0mm	P-5	F-2	0-4	T-5	E-4
516	50572	400	14-16	13-15	-	2,0x15,0mm	P-5	F-2	0-4	T-5	E-4
504 air	41222	240	6	5	-	2,0x15,0mm	P-5	F-2	-	T-5	E-4
506 air	51322	260	12-14	11-13	-	2,0x15,0mm	P-5	F-2	-	T-5	E-4
510 air	51422	260	12-14	11-13	-	2,0x15,0mm	P-5	F-2	-	T-5	E-4
510 L plus air	51472	310	18-20	17-19	-	2,0x15,0mm	P-5	F-2	0-4	T-5	E-4
514 air	51522	310	18-20	17-19	-	2,0x15,0mm	P-5	F-2	0-4	T-5	E-4
516 air	51572	400	14-16	13-15	-	2,0x15,0mm	P-5	F-2	0-4	T-5	E-4
604	40230	240	3	2	-	0,8x12,0mm	P-6	F-3	-	-	-
606	40330	260	6	5	-	0,8x12,0mm	P-6	F-3	-	T-6	-
610	40430	260	7	6	-	0,8x12,0mm	P-6	F-3	-	T-6	-
614	40530	310	11	9	-	0,8x12,0mm	P-6	F-3	-	T-6	-
616	40630	400	14	11	-	0,8x12,0mm	P-6	F-3	-	T-6	-
604 air	41230	240	3	2	-	0,8x12,0mm	P-6	F-3	-	-	-
606 air	41330	260	6	5	-	0,8x12,0mm	P-6	F-3	-	T-6	-
610 air	41430	260	7	6	-	0,8x12,0mm	P-6	F-3	-	T-6	-
614 air	41530	310	11	9	-	0,8x12,0mm	P-6	F-3	-	T-6	-
616 air	41630	400	14	11	-	0,8x12,0mm	P-6	F-3	-	T-6	-
706	40334	260	6	5	-	1,0x4,7mm	P-7	F-3	-	T-6	-
710	40434	260	6	5	-	1,0x4,7mm	P-7	F-3	-	T-6	-
710 L plus	40484	310	9	7	-	1,0x4,7mm	P-7	F-3	-	T-6	-
714	40534	310	9	7	-	1,0x4,7mm	P-7	F-3	-	T-6	-
716	40634	400	12	9	-	1,0x4,7mm	P-7	F-3	-	T-6	-
706 air	41334	260	6	5	-	1,0x4,7mm	P-7	F-3	-	T-6	-
710 air	41434	260	6	5	-	1,0x4,7mm	P-7	F-3	-	T-6	-
714 air	41534	310	9	7	-	1,0x4,7mm	P-7	F-3	-	T-6	-
716 air	41634	400	12	9	-	1,0x4,7mm	P-7	F-3	-	T-6	-



	Velocidade m/min	220-240V 50-60Hz	100-120V 50-60Hz		Dimensões A x L x P mm	Volume de recolha I	Peso kg
							
<=52dB/A	4,7	900W	900W	-	890x734x511	140	64,5
<=52dB/A	5,7	900W	900W	-	960x734x511	160	69,0
<=47dB/A	6,0	350W	400W		705x430x350	40	25,0
<=46dB/A	4,4	650W	680W		865x545x435	60	44,0
<=53dB/A	4,4	650W	680W		944x545x435	100	46,0
<=53dB/A	4,8	900W	900W		944x545x435	100	59,0
<=52dB/A	4,8	900W	900W		890x734x511	140	68,5
<=53dB/A	5,6	900W	900W		960x734x511	160	75,0
<=47dB/A	6,0	350W	400W		705x430x350	40	26,0
<=46dB/A	4,4	650W	680W		865x545x435	60	43,0
<=53dB/A	4,4	650W	680W		944x545x435	100	47,0
<=53dB/A	4,8	900W	900W		944x545x435	100	60,0
<=53dB/A	4,8	900W	900W		890x734x511	140	69,5
<=53dB/A	5,6	900W	900W		960x734x511	160	76,0
<=50dB/A	6,0	350W	400W		705x430x350	40	25,0
<=47dB/A	3,5	650W	680W		865x545x435	60	43,0
<=52dB/A	4,3	650W	680W		944x545x435	100	45,0
<=50dB/A	4,5	900W	900W		890x734x511	140	64,0
<=50dB/A	4,0	1650W	1650W		960x734x511	160	92,0
<=50dB/A	6,0	350W	400W		705x430x350	40	26,0
<=47dB/A	3,5	650W	680W		865x545x435	60	44,0
<=52dB/A	4,3	650W	680W		944x545x435	100	46,0
<=50dB/A	4,5	900W	900W		890x734x511	140	65,0
<=50dB/A	4,0	1650W	1650W		960x734x511	160	93,0
<=50dB/A	6,5	650W	680W		865x545x435	60	43,0
<=52dB/A	6,5	650W	680W		944x545x435	100	45,0
<=52dB/A	7,0	900W	900W		944x545x435	100	60,0
<=52dB/A	7,0	900W	900W		890x734x511	140	64,0
<=52dB/A	8,0	1650W	1650W		960x734x511	160	92,0
<=50dB/A	6,5	650W	680W		865x545x435	60	44,0
<=52dB/A	6,5	650W	680W		944x545x435	100	46,0
<=52dB/A	7,0	900W	900W		890x734x511	140	65,0
<=52dB/A	8,0	1650W	1650W		960x734x511	160	93,0



1.

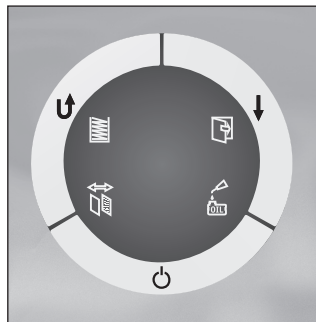

### Por favor observe as indicações de segurança.

1. Antes da utilização da trituradora de papel, verificar a posição do recipiente de recolha para CD/DVD e cartões de crédito e cheque. Ao triturar papel este terá de se encontrar na área dianteira do recipiente de recolha para papel.
2. Fechar a porta da trituradora de papel.
3. Ligar o cabo de ligação fornecido à trituradora de papel e a uma tomada de rede. Ligar o interruptor principal. Depois de ligar o interruptor principal, aguardar 2 a 3 seg.
4. Ligar a trituradora de papel no botão de ligar, desligar e de paragem.



1.1

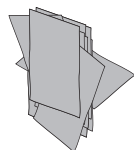

O.K.



### 1. Observar o número máximo de folhas nos dados técnicos!

2. Introduzir o papel no centro da alimentação do papel. A barreira fotoelétrica instalada inicia automaticamente a trituradora de papel.
3. Logo que a alimentação do papel esteja livre, a trituradora de papel desliga-se automaticamente e passa para o modo operacional.
4. Pré-funcionamento permanente – após um acionamento prolongado (aprox. 5 seg.) do botão de avanço, a trituradora de papel passa para o pré-funcionamento permanente.
5. Se a alimentação do papel for interrompida por 15 segundos, o pré-funcionamento permanente desliga-se.





Conforme a variante do modelo a sua trituradora de papel não possui todos os componentes nem todas as funções possíveis.

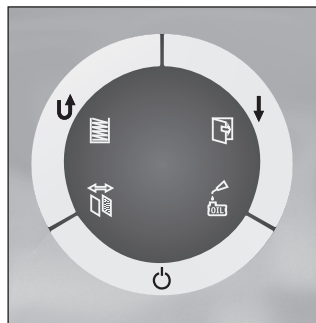
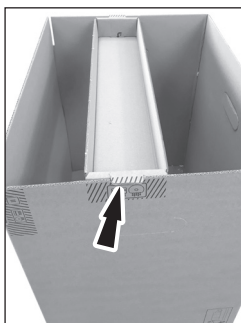

**Por favor, observe as indicações de segurança: Utilizar óculos de proteção para triturar CD/DVD!**

1. Antes da utilização da trituradora de papel, verificar a posição do recipiente de recolha para CD/DVD e cartões de crédito e cheque. Na trituração de CD/DVD e cartões de crédito e cheque este tem de se encontrar na área traseira do recipiente de recolha para papel.
2. Retirar para fora o recipiente de recolha e posicionar para trás o recipiente de recolha para CD/DVD e cartões de crédito/cheques.
3. Fechar a porta da trituradora de papel.
4. Ligar a trituradora de papel no botão de ligar, desligar e de paragem.



1. Introduzir os CD, DVD ou cartões de crédito/cheque no centro da alimentação e manter o botão de avanço premido.
2. Logo que a alimentação dos CD/DVD esteja livre, a trituradora de papel desliga-se automaticamente e passa para o modo operacional.



Conforme a variante do modelo a sua trituradora de papel não possui todos os componentes nem todas as funções possíveis.

## DAHLE CleanTEC®

### Substituir filtro de poeiras finas DAHLE

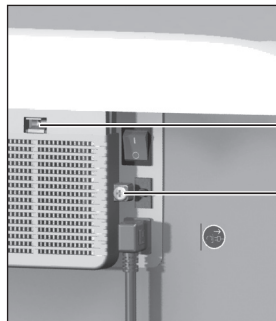
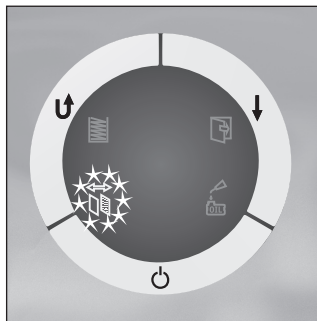
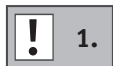

1. A indicação da substituição do filtro (**Substituir filtro de poeiras finas DAHLE!**) acende no painel de comando.
2. Retirar o cabo de ligação da tomada de rede.
3. Substituir o filtro de poeiras finas na parte de trás do aparelho.
  - A. Soltar o parafuso
  - B. Pressionar o travamento e retirar a tampa
  - C. Retirar o filtro e eliminar. Colocar obrigatoriamente um **filtro de poeiras finas DAHLE!**
  - D. Fechar tampa
  - E. Apertar parafuso
4. Ligar o cabo de ligação à tomada de rede e ligar o interruptor principal e o botão de ligar, desligar e de paragem.
5. Repor a indicação da substituição do filtro: mantenha o botão de avanço e de retorno premido em simultâneo durante aprox. 5 segundos.

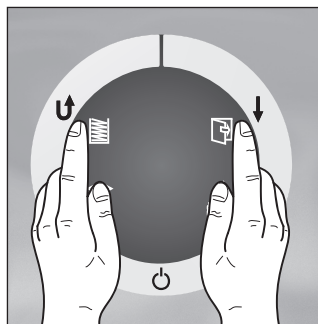

**Não assumimos qualquer tipo de responsabilidade pela aplicação incorreta do filtro de poeiras finas DAHLE e pela falta de substituição do filtro de poeiras finas DAHLE.**

**O filtro de poeiras finas DAHLE usado pode ser eliminado no lixo doméstico.**

**As partículas das poeiras finas estão concentradas no filtro de poeiras finas DAHLE.**

**Eliminar o filtro de poeiras finas DAHLE fora do alcance das crianças.**



Conforme a variante do modelo a sua trituradora de papel não possui todos os componentes nem todas as funções possíveis.

## Lubrificação automática (apenas corte de partículas P5, P6, P7)

Abastecer depósito de óleo com óleo da trituradora de papel DAHLE.

Depósito de óleo integrado para uma lubrificação automática regrada dos rolos.

! 2.

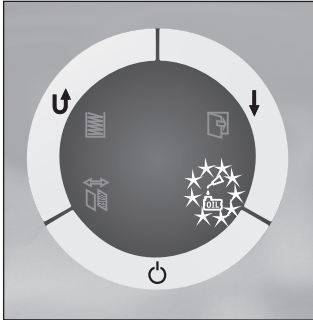

1



2

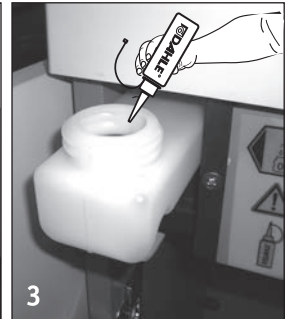

3

Abastecer o depósito de óleo integrado na trituradora de papel quando surgir a indicação no visor.

1. Desligar a trituradora de papel no botão de ligar, desligar e de paragem.
2. Abrir a porta, no armário encontra-se o depósito de óleo integrado. Abrir a tampa de fecho.
3. Abastecer o depósito de óleo com óleo (utilizar óleo da trituradora de papel DAHLE!) e fechar novamente.



Conforme a variante do modelo a sua trituradora de papel não possui todos os componentes nem todas as funções possíveis.

Recipiente de recolha cheio – O LED pisca.

3.

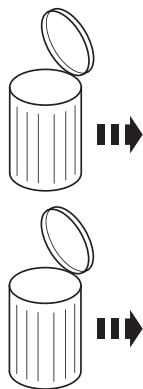
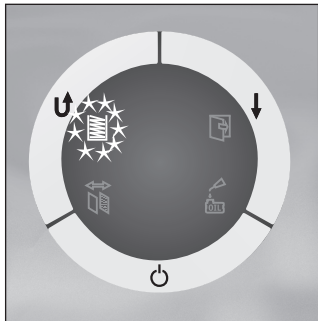

1. Com o recipiente de recolha cheio o processo de corte é interrompido, isto é indicado de forma ótica.
2. Desligar o interruptor principal e retirar o cabo de ligação da tomada de rede.
3. Retirar o recipiente de recolha, esvaziá-lo e encaixá-lo.
4. Ligar o cabo de ligação à tomada de rede e ligar o interruptor principal.



Conforme a variante do modelo a sua trituradora de papel não possui todos os componentes nem todas as funções possíveis.

**Desativação automática do motor** - Os LEDs indicadores do nível de enchimento e da porta piscam.

4.

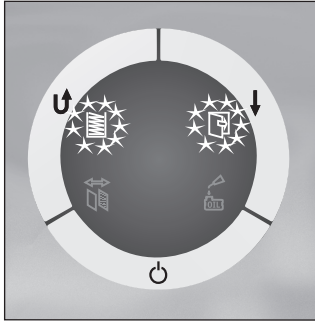

1. Desativação automática do motor em caso de:
  - Sobreaquecimento do motor
  - Acumulação de papel

**Porta aberta** - O LED pisca.

5.

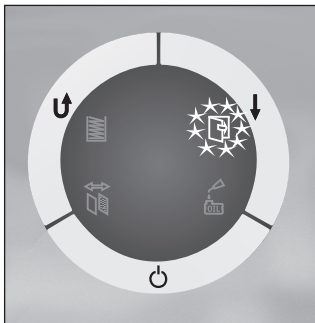

1. Com a porta aberta é interrompido o processo de corte e o LED pisca. Fechar a porta.

Conforme a variante do modelo a sua trituradora de papel não possui todos os componentes nem todas as funções possíveis.

? 1.

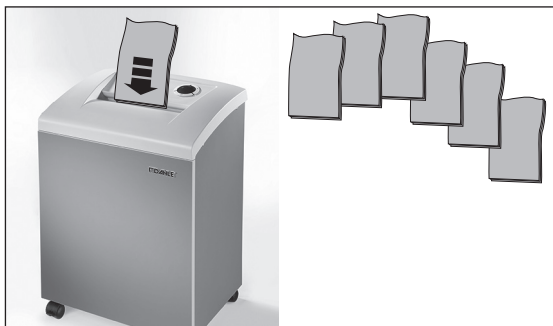

A trituradora de papel desliga automaticamente para arrefecer após um funcionamento prolongado e/ou em caso de sobrecarga.

? 2.



Interruptor de proteção térmica

### O processo de corte não é iniciado:

- Cabo de ligação não se encontra ligado à tomada de rede
- Recipiente de recolha cheio
- Interruptor principal não está ligado?
- Aparelho sobrecarregado/sobreaquecido?
- Botão de ligar, desligar e de paragem não ligado?
- Interruptor de proteção térmica OFF?
- Porta aberta

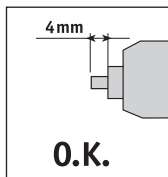
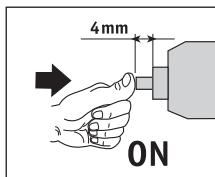
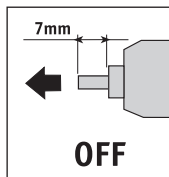

Colocar o interruptor de proteção térmica na posição correta: ON.

Conforme a variante do modelo a sua trituradora de papel não possui todos os componentes nem todas as funções possíveis.

3.

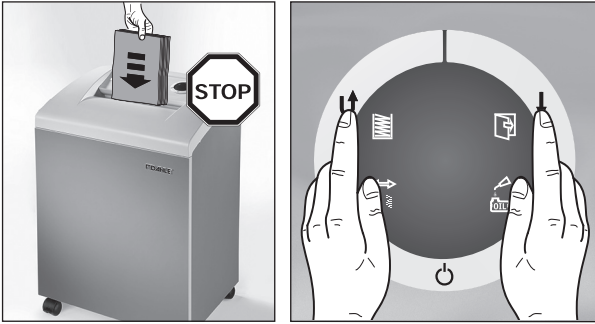

1. Se a quantidade de papel for muito elevada o processo de corte é interrompido.
2. O dispositivo de corte funciona por breves instantes de forma inversa e o papel é extraído.
3. **ATENÇÃO: não utilizar o botão de avanço e de retorno alternadamente, para que o dispositivo de corte não seja danificado!**

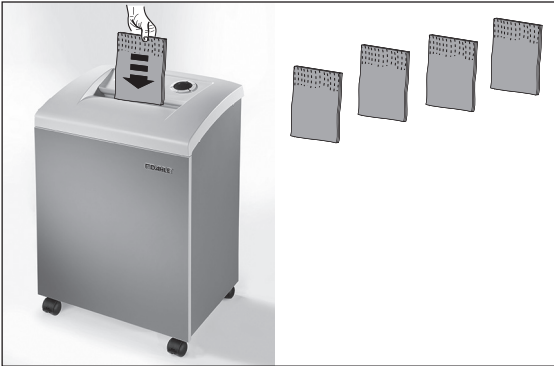

4. Se o papel continuar encravado, acionar por breves instantes o botão de retorno.
5. Reduzir a quantidade de folhas retirando-as ou rasgando-as.
6. Após nova introdução do papel o processo de corte inicia automaticamente. Caso contrário acionar o botão de avanço.

#### 706, 710, 710 L plus, 714, 716, 706 air, 710 air, 714 air, 716 air

1. Em caso de uma acumulação de papel o dispositivo de corte trabalha por 5 segundos em direcção oposta.
2. Retirar o papel. Accionar de seguida o interruptor de avanço para libertar o dispositivo de corte. O interruptor de retomo está bloqueado até que seja accionado o interruptor de avanço.
3. Reduzir a quantidade de papel.



Conforme a variante do modelo a sua trituradora de papel não possui todos os componentes nem todas as funções possíveis.

## Modo de poupança de energia

? 4.



Em caso de não utilização, a trituradora de papel desliga-se após aprox. 30 minutos (LED apagado). Para utilização, a trituradora de papel deve ser ligada novamente no botão de ligar, desligar e de paragem.





Utilizar apenas peças de substituição DAHLE!

## Lubrificar (corte de partículas P5)



Lubrificar o dispositivo de corte quando a capacidade de corte começar a diminuir, após cada esvaziamento do recipiente de recolha ou o mais tardar após decorrido o tempo de funcionamento indicado na indicação de aviso (**apenas com corte de partículas P5**).

1. Desligar a trituradora de papel no botão de ligar, desligar e de paragem. Lubrificar os rolos de corte manualmente (utilizar o óleo da trituradora de papel DAHLE!).
2. Ligar a trituradora de papel no botão de ligar, desligar e de paragem, deixar o dispositivo de corte trabalhar sem alimentação de papel no modo de retorno durante 10 segundos.

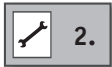

1. Desligar a trituradora de papel e retirar o cabo de ligação da tomada de rede.
2. Limpar o aparelho apenas com um pano seco.
3. Ligar o cabo de ligação à tomada de rede e ligar a trituradora de papel.





**Voordat u de papiervernietiger gebruikt, dient u aandachtig de gebruiksaanwijzing en veiligheidsaanwijzingen te lezen! Volg alle veiligheidsvoorschriften! Bewaar de documentatie voor later gebruik.**

- De papiervernietiger uitsluitend oprecht opslaan, transporteren en gebruiken!
- Gebruik voor de papiervernietiger uitsluitend vloeistoffen en gassen die aan de DAHLE-richtlijnen voldoen!
- De papiervernietiger moet in gesloten ruimtes met een temperatuur van 15 °C tot 32 °C (59 °F tot 90 °F) en een niet-condenserende luchtvochtigheid van 15 % tot 95 % worden gebruikt!
- De papiervernietiger mag niet in de nabijheid van een warmtebron worden geplaatst!
- De papiervernietiger moet op een stabiele ondergrond en op een afstand van 100 mm tot de wand worden opgesteld, vastzetremmen gebruiken en met de optioneel meegeleverde montageset bevestigen!
- Warmte-ophoping vermijden!
- Het geaarde stopcontact moet op elk moment gemakkelijk toegankelijk zijn!
- Uitsluitend de meegeleverde, onbeschadigde stroomkabel van het bedrijf DAHLE gebruiken!
- Er moet een kortsluitingszekering in de elektrische installatie van het gebouw aanwezig zijn van max. 16A (VS max. 20A)!
- Niet gebruiken in de nabijheid van ontvlambare vloeistoffen en gassen!
- Niet gebruiken in de nabijheid van agressieve stoffen!
- Niet aan vochtigheid blootstellen!
- Het apparaat mag niet worden geopend!
- Automatische start!
- De papiervernietiger niet stationair/onbelast gebruiken!
- Schakel de papiervernietiger uit met de hoofdschakelaar als het apparaat niet wordt gebruikt!
- De papiervernietiger alleen in perfecte staat gebruiken, rekening houdend met de gebruiksaanwijzing, de standaardvoorschriften en -richtlijnen alsmede de geldende veiligheidsvoorschriften en de voorschriften ter voorkoming van ongevallen. Als er storingen optreden, moet de papiervernietiger direct buiten werking worden gesteld!
- Het apparaat is niet bedoeld voor gebruik door personen (inclusief kinderen) met verminderde lichamelijke, zintuiglijke of verstandelijke vermogens of gebrek aan ervaring en kennis, tenzij ze werken onder toezicht of instructies krijgen over het gebruik van het apparaat door een persoon die verantwoordelijk is voor de veiligheid.



- 1 - De veiligheidsvoorschriften moeten worden toegepast!
- 2 - **Voordat u de papiervernietiger gebruikt, dient u aandachtig de gebruiksaanwijzing en veiligheidsaanwijzingen te lezen!**
- 3 - Deze papiervernietiger is niet bedoeld voor gebruik door kinderen (dit product is geen speelgoed)!
- 4 - Raak de papierinvoeropening niet aan met uw handen!
- 5 - Raak de papierinvoeropening niet aan met kledingstukken!
- 6 - Raak de papierinvoeropening niet aan met haren!
- 7 - Om onderhoudswerkzaamheden aan de papiervernietiger uit te voeren, dient men eerst de stekker uit het stopcontact te halen!
- 8 - Bij het vernietigen van cd's/dvd's moet een veiligheidsbril worden gedragen!
- 8 - Voor men papier versnipperd, moet men paperclips en nietjes verwijderen!  
(apparaten met veiligheidsniveau P6 en P7)



## Waarschuwingsaanwijzingen naleven!



- 1 - Bedrijfsgeluidsterkte bij onbelast/stationair gebruik (volgens DIN)
- 2 - Papiervernietiger gereed
- 3 - Papiervernietiger in bedrijf
- 4 - Automatische start
- 5 - Smeren (uitsluitend DAHLE-olie gebruiken!)
- 6 - Lever de papiervernietiger voor een milieuvriendelijke en vakkundige afvalverwerking in bij een bevoegd verwerkingsbedrijf. Zet geen delen van de papiervernietiger of het verpakkingsmateriaal bij het huisvuil

## Bedoeld gebruik, garantieaanspraak

De papiervernietiger is bedoeld voor het versnipperen van papier. Afhankelijk van de modelvariant kunnen naast papier ook kleine hoeveelheden van de volgende materialen worden vernietigd:

- cd's/dvd's, betaalpasjes en creditcards (zie Technische gegevens)
- In papieren documenten aanwezige nietjes en paperclips (uitzondering: apparaten met veiligheidsniveau P6 en P7)

Slijtage of schade door onjuist gebruik vallen net als ingrepen van derden noch onder de garantieaanspraak, noch onder de garantie

De papiervernietiger is ontworpen voor privé gebruik en normaal gebruik in een kantooromgeving.

De volgende voorwaarden zijn van toepassing op de prestaties van het vel gespecificeerd onder technische gegevens:

Maximumaantal vellen in één keer gesneden onder de volgende omstandigheden: Nieuwe of geoliede snijrollen, koude motor, voeding met nominale spanning en nominale frequentie (230 V/50 Hz, 120 V/60 Hz). Afwijkingen kunnen leiden tot lagere prestaties en meer geluid. De vellen worden in het midden en in de lengte onder 90° ingevoerd. Afhankelijk van de papiereigenschappen en invoer, kan de veluitvoer ook variëren.

## Technische wijzigingen voorbehouden!

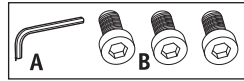
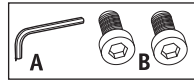
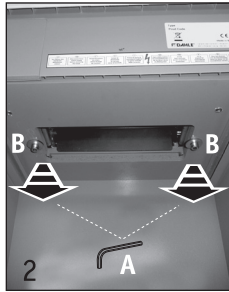
**Transportbescherming verwijderen!**

1. Vastzetremmen gebruiken! Open voor het eerste gebruik de deur, verwijder de papieropvangbak.
2. Verwijder de schroeven van de transportbescherming (in het inschuifbereik van de papieropvangbak) uit de bodemplaat onder het snijmechanisme, schuif opnieuw de papieropvangbak in het apparaat en sluit de deur.
3. Bij elke verplaatsing van locatie dient men de transportbescherming opnieuw aan te brengen.

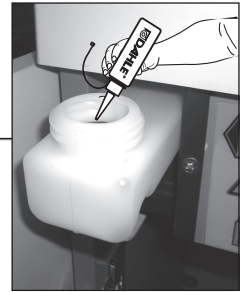
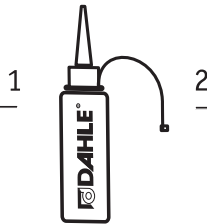
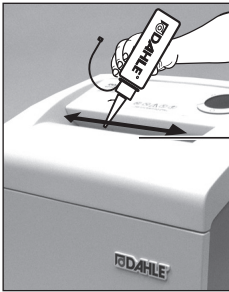

1. Smeer de snijwalsen in met DAHLE-olie voor de papiervernietiger (uitsluitend partikelsnijden P5, P6 en P7)!
2. Vul het oliereservoir met DAHLE-olie voor de papiervernietiger!



Afhankelijk van de modelvariant bevat uw papiervernietiger niet alle mogelijke componenten en functies.

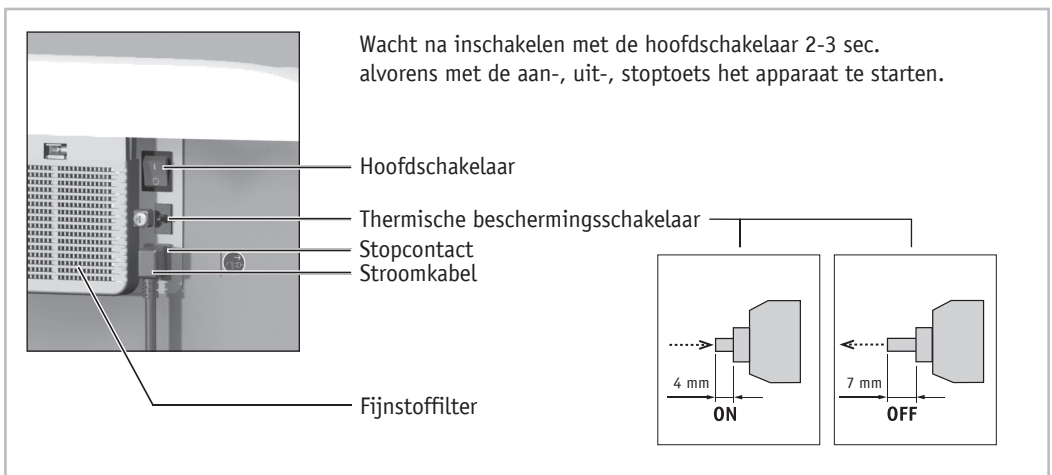
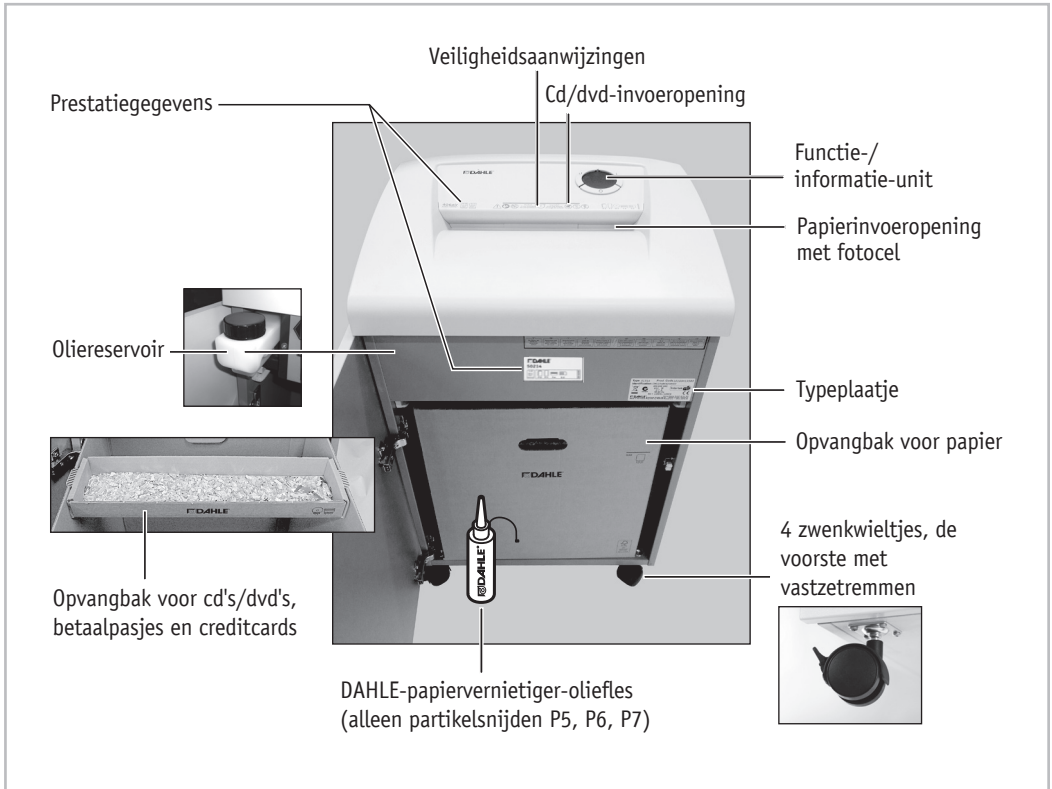





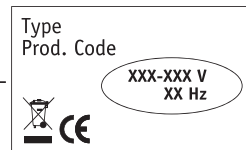
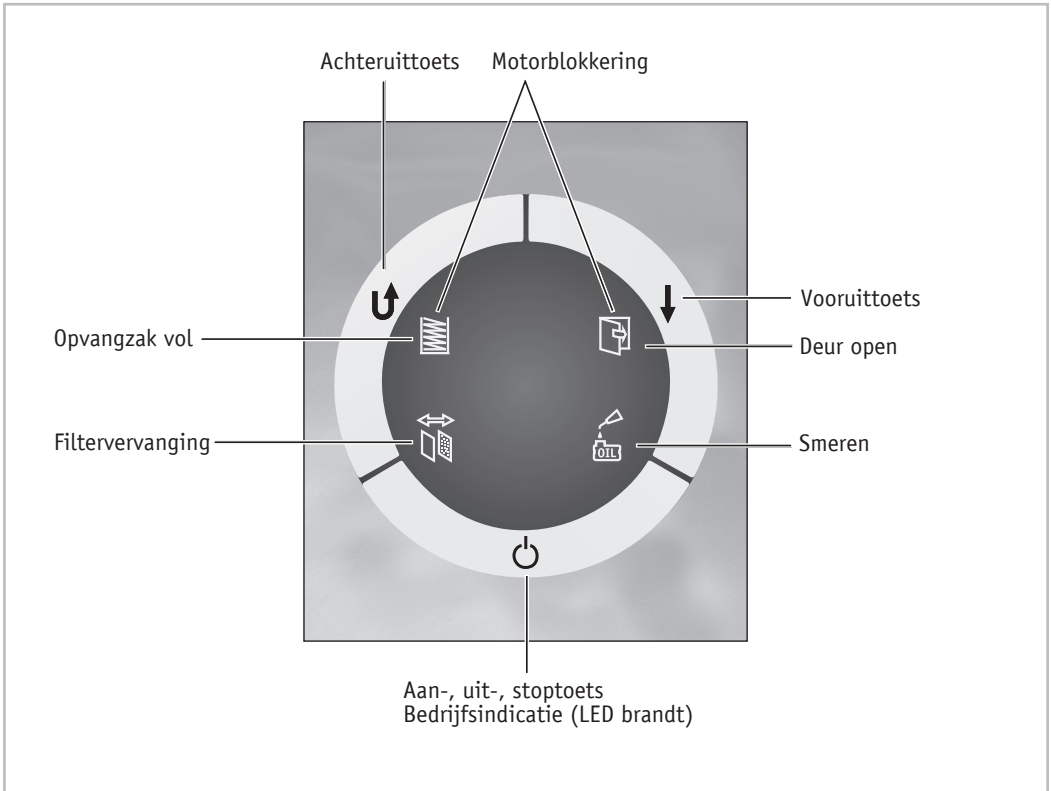





Afhankelijk van de modelvariant bevat uw papiervernietiger niet alle mogelijke componenten en functies.







1. Controleer of de spanning en stroomfrequentie van uw stroomnetwerk overeenkomen met de gegevens op het typeplaatje.













































							Beveiligingsniveaus volgens DIN 66399*				
							P	F	0	T	E
			DIN A4- 70g/m <sup>2</sup>	DIN A4- 80g/m <sup>2</sup>							
104	40206	240	19	16	5,8mm	-	P-2	-	0-2	T-2	E-2
106	40306	260	27	22	5,8mm	-	P-2	-	0-2	T-2	E-2
110	40406	260	29	23	5,8mm	-	P-2	-	0-2	T-2	E-2
114	40506	310	43	35	5,8mm	-	P-2	-	0-2	T-2	E-2
116	40606	400	45	36	5,8mm	-	P-2	-	0-2	T-2	E-2
104 air	41206	240	19	16	5,8mm	-	P-2	-	0-2	T-2	E-2
106 air	41306	260	27	22	5,8mm	-	P-2	-	0-2	T-2	E-2
110 air	41406	260	29	23	5,8mm	-	P-2	-	0-2	T-2	E-2
114 air	41506	310	43	35	5,8mm	-	P-2	-	0-2	T-2	E-2
116 air	41606	400	45	36	5,8mm	-	P-2	-	0-2	T-2	E-2
203	40104	220	15	13	3,9mm	-	P-2	-	-	T-2	E-2
204	40204	240	17	14	3,9mm	-	P-2	-	-	T-2	E-2
206	40304	260	23	18	3,9mm	-	P-2	-	0-2	T-2	E-2
210	40404	260	24	19	3,9mm	-	P-2	-	0-2	T-2	E-2
214	40504	310	33	26	3,9mm	-	P-2	-	0-2	T-2	E-2
216	40604	400	35	28	3,9mm	-	P-2	-	0-2	T-2	E-2
204 air	41204	240	17	14	3,9mm	-	P-2	-	-	T-2	E-2
206 air	41304	260	23	18	3,9mm	-	P-2	-	0-2	T-2	E-2
210 air	41404	260	24	19	3,9mm	-	P-2	-	0-2	T-2	E-2
214 air	41504	310	33	26	3,9mm	-	P-2	-	0-2	T-2	E-2
216 air	41604	400	35	28	3,9mm	-	P-2	-	0-2	T-2	E-2
306	50310	260	19-21	18-20	-	5,0x50mm	P-3	-	0-3	T-3	E-2
310	50410	260	19-21	18-20	-	5,0x50mm	P-3	-	0-3	T-3	E-2
306 air	51310	260	19-21	18-20	-	5,0x50mm	P-3	-	0-3	T-3	E-2
310 air	51410	260	19-21	18-20	-	5,0x50mm	P-3	-	0-3	T-3	E-2
403	50114	240	8-10	7-9	-	4,0x40,0mm	P-4	F-1	-	T-4	E-3
404	50214	240	8-10	7-9	-	4,0x40,0mm	P-4	F-1	-	T-4	E-3
406	50314	260	17-19	15-17	-	4,0x40,0mm	P-4	F-1	0-3	T-4	E-3
410	50414	260	17-19	15-17	-	4,0x40,0mm	P-4	F-1	0-3	T-4	E-3
410 L plus	50464	310	25-27	24-26	-	4,0x40,0mm	P-4	F-1	0-3	T-4	E-3
414	50514	310	25-27	24-26	-	4,0x40,0mm	P-4	F-1	0-3	T-4	E-3
416	50564	400	19-21	18-20	-	4,0x40,0mm	P-4	F-1	0-3	T-4	E-3
404 air	51214	240	8-10	7-9	-	4,0x40,0mm	P-4	F-1	-	T-4	E-3
406 air	51314	260	17-19	15-17	-	4,0x40,0mm	P-4	F-1	0-3	T-4	E-3
410 air	51414	260	17-19	15-17	-	4,0x40,0mm	P-4	F-1	0-3	T-4	E-3
410 L plus air	51464	310	25-27	24-26	-	4,0x40,0mm	P-4	F-1	0-3	T-4	E-3



		220-240V 50-60Hz	100-120V 50-60Hz				
	Snelheid m/min				Afmetingen H x B x D mm	Opvangin- houd I	Gewicht kg
<=47dB/A	6,0	350W	400W	-	705x430x350	40	25,0
<=47dB/A	4,0	650W	680W	-	865x545x435	60	43,0
<=51dB/A	4,4	650W	680W	-	944x545x435	100	45,0
<=46dB/A	4,5	900W	900W	-	890x734x511	140	64,0
<=50dB/A	6,0	1650W	1650W	-	960x734x511	160	92,0
<=47dB/A	6,0	350W	400W	-	705x430x350	40	26,0
<=47dB/A	4,0	650W	680W	-	865x545x435	60	44,0
<=51dB/A	4,4	650W	680W	-	944x545x435	100	46,0
<=46dB/A	4,5	900W	900W	-	890x734x511	140	65,0
<=50dB/A	6,0	1650W	1650W	-	960x734x511	160	93,0
<=49dB/A	6,0	350W	400W	-	628x430x350	30	22,5
<=46dB/A	6,0	350W	400W	-	705x430x350	40	25,0
<=46dB/A	4,0	650W	680W	-	865x545x435	60	43,0
<=51dB/A	4,4	650W	680W	-	944x545x435	100	45,0
<=47dB/A	4,5	900W	900W	-	890x734x511	140	64,0
<=49dB/A	6,0	1650W	1650W	-	960x734x511	160	92,0
<=46dB/A	6,0	350W	400W	-	705x430x350	40	26,0
<=46dB/A	4,0	650W	680W	-	865x545x435	60	44,0
<=51dB/A	4,4	650W	680W	-	944x545x435	100	46,0
<=47dB/A	4,5	900W	900W	-	890x734x511	140	65,0
<=49dB/A	6,0	1650W	1650W	-	960x734x511	160	93,0
<=46dB/A	4,5	650W	680W	-	865x545x435	60	43,0
<=46dB/A	4,5	650W	680W	-	944x545x435	100	45,0
<=46dB/A	4,5	650W	680W	-	865x545x435	60	43,5
<=46dB/A	4,5	650W	680W	-	944x545x435	100	45,5
<=44dB/A	6,5	350W	400W	-	628x430x350	30	23,0
<=46dB/A	6,5	350W	400W	-	705x430x350	40	25,0
<=46dB/A	4,5	650W	680W	-	865x545x435	60	43,0
<=52dB/A	4,5	650W	680W	-	944x545x435	100	45,0
<=52dB/A	4,7	900W	900W	-	944x545x435	100	54,5
<=52dB/A	4,7	900W	900W	-	890x734x511	140	64,0
<=52dB/A	5,7	900W	900W	-	960x734x511	160	68,5
<=46dB/A	6,5	350W	400W	-	705x430x350	40	25,5
<=46dB/A	4,5	650W	680W	-	865x545x435	60	43,5
<=52dB/A	4,5	650W	680W	-	944x545x435	100	45,5
<=52dB/A	4,7	900W	900W	-	944x545x435	100	55,0



		Beveiligingsniveaus volgens DIN 66399*									
							P	F	0	T	E
			DIN A4-70g/m <sup>2</sup>	DIN A4-80g/m <sup>2</sup>							
414 air	51514	310	25-27	24-26	-	4,0x40,0mm	P-4	F-1	0-3	T-4	E-3
416 air	51564	400	19-21	18-20	-	4,0x40,0mm	P-4	F-1	0-3	T-4	E-3
504	40222	240	6	5	-	2,0x15,0mm	P-5	F-2	-	T-5	E-4
506	50322	260	12-14	11-13	-	2,0x15,0mm	P-5	F-2	-	T-5	E-4
510	50422	260	12-14	11-13	-	2,0x15,0mm	P-5	F-2	-	T-5	E-4
510 L plus	50472	310	18-20	17-19	-	2,0x15,0mm	P-5	F-2	0-4	T-5	E-4
514	50522	310	18-20	17-19	-	2,0x15,0mm	P-5	F-2	0-4	T-5	E-4
516	50572	400	14-16	13-15	-	2,0x15,0mm	P-5	F-2	0-4	T-5	E-4
504 air	41222	240	6	5	-	2,0x15,0mm	P-5	F-2	-	T-5	E-4
506 air	51322	260	12-14	11-13	-	2,0x15,0mm	P-5	F-2	-	T-5	E-4
510 air	51422	260	12-14	11-13	-	2,0x15,0mm	P-5	F-2	-	T-5	E-4
510 L plus air	51472	310	18-20	17-19	-	2,0x15,0mm	P-5	F-2	0-4	T-5	E-4
514 air	51522	310	18-20	17-19	-	2,0x15,0mm	P-5	F-2	0-4	T-5	E-4
516 air	51572	400	14-16	13-15	-	2,0x15,0mm	P-5	F-2	0-4	T-5	E-4
604	40230	240	3	2	-	0,8x12,0mm	P-6	F-3	-	-	-
606	40330	260	6	5	-	0,8x12,0mm	P-6	F-3	-	T-6	-
610	40430	260	7	6	-	0,8x12,0mm	P-6	F-3	-	T-6	-
614	40530	310	11	9	-	0,8x12,0mm	P-6	F-3	-	T-6	-
616	40630	400	14	11	-	0,8x12,0mm	P-6	F-3	-	T-6	-
604 air	41230	240	3	2	-	0,8x12,0mm	P-6	F-3	-	-	-
606 air	41330	260	6	5	-	0,8x12,0mm	P-6	F-3	-	T-6	-
610 air	41430	260	7	6	-	0,8x12,0mm	P-6	F-3	-	T-6	-
614 air	41530	310	11	9	-	0,8x12,0mm	P-6	F-3	-	T-6	-
616 air	41630	400	14	11	-	0,8x12,0mm	P-6	F-3	-	T-6	-
706	40334	260	6	5	-	1,0x4,7mm	P-7	F-3	-	T-6	-
710	40434	260	6	5	-	1,0x4,7mm	P-7	F-3	-	T-6	-
710 L plus	40484	310	9	7	-	1,0x4,7mm	P-7	F-3	-	T-6	-
714	40534	310	9	7	-	1,0x4,7mm	P-7	F-3	-	T-6	-
716	40634	400	12	9	-	1,0x4,7mm	P-7	F-3	-	T-6	-
706 air	41334	260	6	5	-	1,0x4,7mm	P-7	F-3	-	T-6	-
710 air	41434	260	6	5	-	1,0x4,7mm	P-7	F-3	-	T-6	-
714 air	41534	310	9	7	-	1,0x4,7mm	P-7	F-3	-	T-6	-
716 air	41634	400	12	9	-	1,0x4,7mm	P-7	F-3	-	T-6	-

	Snelheid m/min	220-240V 50-60Hz	100-120V 50-60Hz		Afmetingen H x B x D mm	Opvangin- houd I	Gewicht kg
							
<=52dB/A	4,7	900W	900W	-	890x734x511	140	64,5
<=52dB/A	5,7	900W	900W	-	960x734x511	160	69,0
<=47dB/A	6,0	350W	400W		705x430x350	40	25,0
<=46dB/A	4,4	650W	680W		865x545x435	60	44,0
<=53dB/A	4,4	650W	680W		944x545x435	100	46,0
<=53dB/A	4,8	900W	900W		944x545x435	100	59,0
<=52dB/A	4,8	900W	900W		890x734x511	140	68,5
<=53dB/A	5,6	900W	900W		960x734x511	160	75,0
<=47dB/A	6,0	350W	400W		705x430x350	40	26,0
<=46dB/A	4,4	650W	680W		865x545x435	60	43,0
<=53dB/A	4,4	650W	680W		944x545x435	100	47,0
<=53dB/A	4,8	900W	900W		944x545x435	100	60,0
<=53dB/A	4,8	900W	900W		890x734x511	140	69,5
<=53dB/A	5,6	900W	900W		960x734x511	160	76,0
<=50dB/A	6,0	350W	400W		705x430x350	40	25,0
<=47dB/A	3,5	650W	680W		865x545x435	60	43,0
<=52dB/A	4,3	650W	680W		944x545x435	100	45,0
<=50dB/A	4,5	900W	900W		890x734x511	140	64,0
<=50dB/A	4,0	1650W	1650W		960x734x511	160	92,0
<=50dB/A	6,0	350W	400W		705x430x350	40	26,0
<=47dB/A	3,5	650W	680W		865x545x435	60	44,0
<=52dB/A	4,3	650W	680W		944x545x435	100	46,0
<=50dB/A	4,5	900W	900W		890x734x511	140	65,0
<=50dB/A	4,0	1650W	1650W		960x734x511	160	93,0
<=50dB/A	6,5	650W	680W		865x545x435	60	43,0
<=52dB/A	6,5	650W	680W		944x545x435	100	45,0
<=52dB/A	7,0	900W	900W		944x545x435	100	60,0
<=52dB/A	7,0	900W	900W		890x734x511	140	64,0
<=52dB/A	8,0	1650W	1650W		960x734x511	160	92,0
<=50dB/A	6,5	650W	680W		865x545x435	60	44,0
<=52dB/A	6,5	650W	680W		944x545x435	100	46,0
<=52dB/A	7,0	900W	900W		890x734x511	140	65,0
<=52dB/A	8,0	1650W	1650W		960x734x511	160	93,0



1.

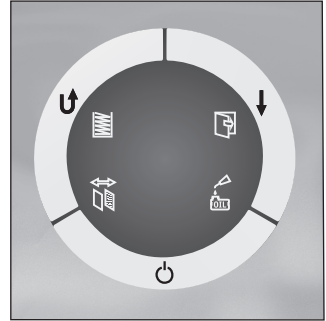

### Let op de veiligheidsaanwijzingen a.u.b.

1. Voordat u de papierversnietiger gaat gebruiken, controleert u de positie van de opvangbak voor cd's/dvd's, betaalpasjes en creditcards. Bij het versnipperen van papier moet deze zich in het voorste deel van de opvangbak voor papier bevinden.
2. Sluit de deur van de papierversnietiger.
3. Verbind de meegeleverde kabelstekker met de papierversnietiger en met een stopcontact. Schakel de hoofdschakelaar in. Wacht na het inschakelen met de hoofdschakelaar 2-3 seconden.
4. Schakel de papierversnietiger in met de aan-, uit-, stop-toets.

1.1

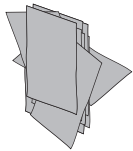

O.K.



### 1. Het maximaal aantal papiervellen van de technische gegevens niet overschrijden!

2. Plaats het papier in het midden van de papierinvoeropening, de ingebouwde fotocel start de papierversnietiger automatisch.
3. Nadat de papierinvoeropening weer vrij is, wordt de papierversnietiger automatisch uitgeschakeld en gaat deze in de gereedstand.
4. Constante loopmodus – Bij het langer indrukken van de vooruittoets (ca. 5 sec.) schakelt de papierversnietiger over in de constante loopmodus.
5. Wordt het toevoeren van papier gedurende 15 seconden onderbroken dan wordt de constante loopmodus uitgeschakeld.



Afhankelijk van de modelvariant bevat uw papiervernietiger niet alle mogelijke componenten en functies.

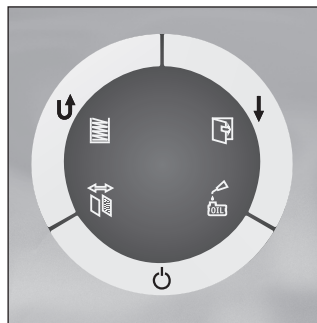
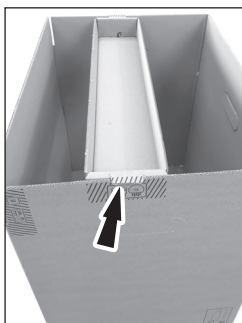

**Let op de veiligheidsaanwijzingen a.u.b.: bij het vernietigen van cd's/dvd's moet een veiligheidsbril worden gedragen!**

1. Voordat u de papiervernietiger gaat gebruiken, controleert u de positie van de opvangbak voor cd's/dvd's, betaalpasjes en creditcards. Bij het versnipperen van cd's/dvd's, betaalpasjes en creditcards moet deze zich in het achterste deel van de opvangbak bevinden.
2. Haal de opvangbak uit het apparaat en plaats de opvangbak voor cd's/dvd's, betaalpasjes en creditcards in het achterste deel van de opvangbak.
3. Sluit de deur van de papiervernietiger.
4. Schakel de papiervernietiger in met de aan-, uit-, stop-toets.



1. Plaats de cd's/dvd's, betaalpasjes of creditcards in het midden van de cd/dvd-invoeropening en houd de vooruittoets ingedrukt.
2. Nadat de cd/dvd-invoeropening weer vrij is, wordt de papiervernietiger automatisch uitgeschakeld en gaat deze in de gereedstand.



Afhankelijk van de modelvariant bevat uw papiervernietiger niet alle mogelijke componenten en functies.

## DAHLE CleanTEC® DAHLE-fijnstoffilter vervangen



1.

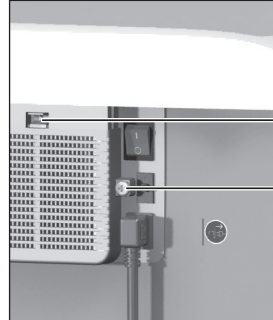
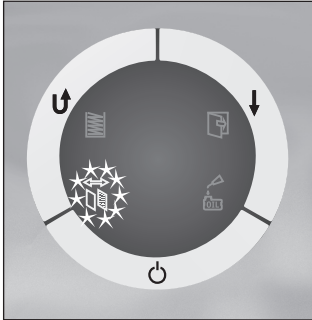

Vergrendelin

Schroef

1. De aanduiding Filterwissel (**DAHLE-fijnstoffilter vervangen!**) brandt op het bedieningspaneel.
2. Haal de kabelstekker uit het stopcontact.
3. Vervang de fijnstoffilter aan de achterzijde van het apparaat.
  - A. Schroef losschroeven
  - B. Vergrendeling indrukken en deksel verwijderen
  - C. Filter verwijderen en milieuvriendelijk verwerken. Bestel weer een **DAHLE-fijnstoffilter** plaatsen!
  - D. Deksel sluiten
  - E. Schroef vastdraaien
4. Sluit het netsnoer aan op het stopcontact, schakel de hoofdschakelaar en de aan-, uit-, stoptoets in.
5. Filtervervangingsweergave resetten: houd gedurende ca. 5 seconden gelijktijdig de voor- en achteruittoets ingedrukt.

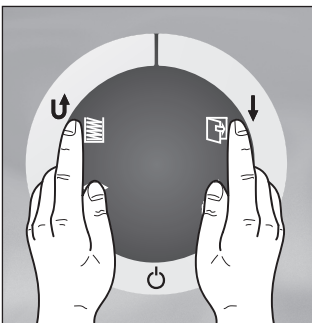

**Wij aanvaarden geen aansprakelijkheid voor onjuist gebruik van de DAHLE-fijnstoffilter en voor het niet vervangen van de DAHLE-fijnstoffilter.**

De gebruikte DAHLE-fijnstoffilter kan gewoon mee met het huisvuil.

De DAHLE-fijnstoffilter bevat fijne stofdeeltjes.

Zorg voor een afvalverwerking van de DAHLE-fijnstoffilter zonder dat deze in handen van kinderen terecht kan komen.



Afhankelijk van de modelvariant bevat uw papiervernietiger niet alle mogelijke componenten en functies.

## Automatisch smeren (alleen partikelsnijden P5, P6 en P7)

Oliereservoir vullen met DAHLE-olie voor de papiervernietiger.

Geïntegreerd oliereservoir voor een geregelde automatische smering van de walsen.

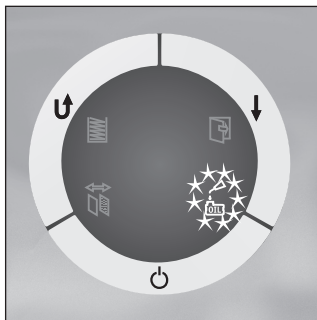

Vul het geïntegreerde oliereservoir van de papiervernietiger bij weergave op het display.

1. Schakel de papiervernietiger uit met de aan-, uit-, stopstoets.
2. Open de deur, in de kast bevindt zich het geïntegreerd oliereservoir, open de vergrendelingskap.
3. Oliereservoir met olie vullen (uitsluitend DAHLE-olie voor de papiervernietiger gebruiken!) en opnieuw sluiten.



Afhankelijk van de modelvariant bevat uw papiervernietiger niet alle mogelijke componenten en functies.

**Opvangbak vol – De LED knippert.**

**!** 3.

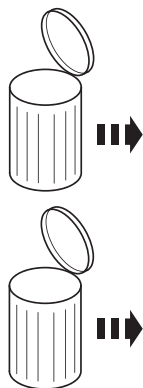
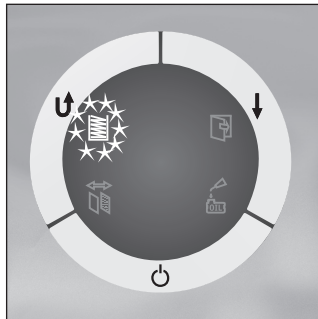

1. Als de opvangbak vol is dan wordt het snijproces gestopt. Dit wordt optisch aangegeven.
2. Schakel de hoofdschakelaar uit en haal de kabelstekker uit het stopcontact.
3. Nu kunt u de opvangbak verwijderen, leegmaken en opnieuw plaatsen.
4. Steek de kabelstekker in het stopcontact en schakel de hoofdschakelaar in.



Afhankelijk van de modelvariant bevat uw papiervernietiger niet alle mogelijke componenten en functies.

**Automatische motoruitschakeling** - De leds Vulstand en Deur knipperen.

!

4.

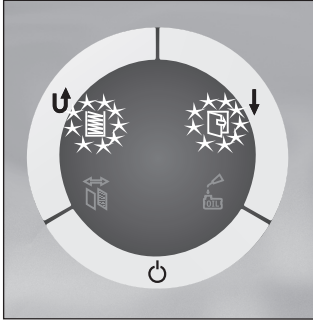

1. Automatische motoruitschakeling bij:
  - oververhitting van de motor
  - papierverstopping

**Deur open** - De LED knippert.

!

5.

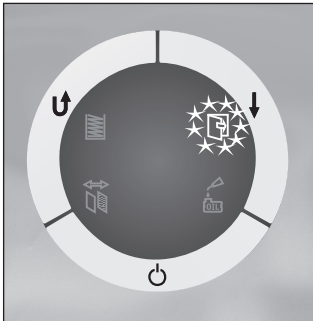

1. Bij een open deur wordt het snijproces gestopt en knippert de led. Sluit de deur.



Afhankelijk van de modelvariant bevat uw papiervernietiger niet alle mogelijke componenten en functies.

? 1.

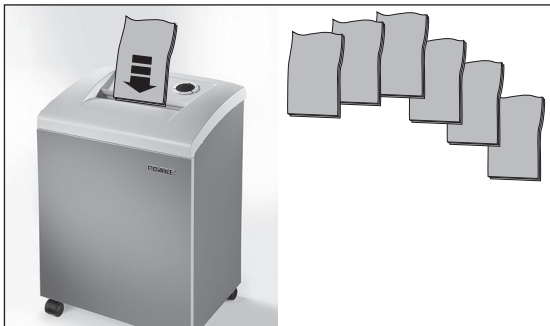

De papiervernietiger wordt automatisch uitgeschakeld bij langdurig gebruik en/of bij overbelasting om af te koelen.

? 2.



Thermoschutzschalter

### Het snijproces wordt niet gestart:

- de kabelstekker zit niet in het stopcontact
- is de hoofdschakelaar ingeschakeld?
- is de aan-, uit-, stoptoets ingeschakeld?
- Deur open
- Opvangbak vol
- Apparaat overbelast/oververhit?
- thermische beschermingsschakelaar OFF?

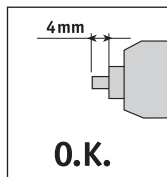
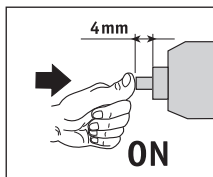
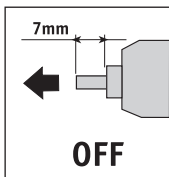

Zet de thermische beschermingsschakelaar in de juiste stand – ON.

Afhankelijk van de modelvariant bevat uw papiervernietiger niet alle mogelijke componenten en functies.

3.

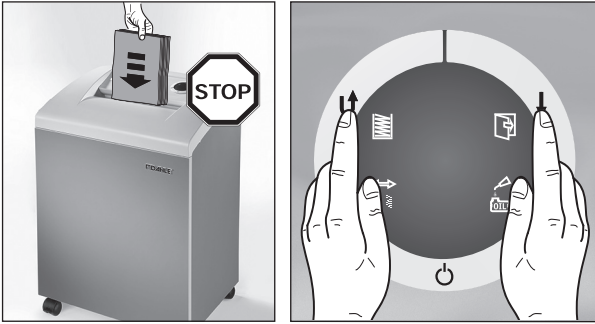

1. Is het aantal papiervellen te hoog dan wordt het vernietigingsproces gestopt.
2. Het snijmechanisme loopt vanzelf kort achteruit en het papier wordt eruit uitgeschoven.
3. **LET OP, voor- en achteruitschakelaar niet afwisselend indrukken, opdat het snijmechanisme niet wordt beschadigd!**

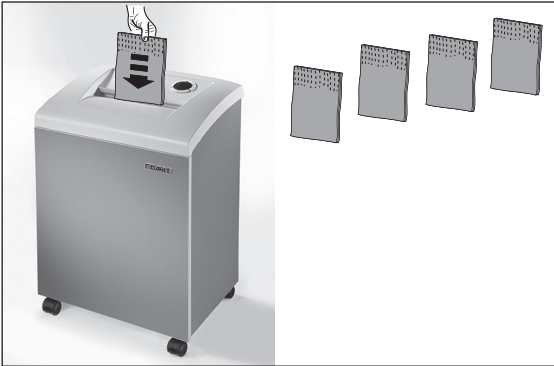

4. Mocht het papier nog vast blijven zitten, druk dan kort de achteruittoets in.
5. Verminder het aantal papiervellen door wat papier te verwijderen of af te scheuren.
6. Na het opnieuw invoeren van het papier start het snijproces automatisch, zo niet, druk dan op de vooruittoets.

#### **706, 710, 710 L plus, 714, 716, 706 air, 710 air, 714 air, 716 air**

1. Bij een papierverslapping loopt het snijmechanisme gedurende 0,5 seconden achteruit.
2. Verwijder het papier. Druk vervolgens de vooruitschakelaar in om het snijmechanisme vrij te maken.  
De achteruitschakelaar blijft geblokkeerd totdat de vooruitschakelaar wordt ingedrukt.
3. Verminder het aantal papiervellen.



Afhankelijk van de modelvariant bevat uw papiervernietiger niet alle mogelijke componenten en functies.

## Energiespaarmodus

? 4.



De papiervernietiger schakelt na ong. 30 minuten inactiviteit automatisch uit (led uit). Voor gebruik moet u de papiervernietiger met de aan-, uit-, stop-toets opnieuw inschakelen.



Gebruik uitsluitend DAHLE-reserveonderdelen!

## Smeren (partikelsnijden P5)

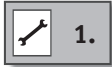

Smeer het snijmechanisme met olie in wanneer het snijvermogen minder wordt, na het legen van de opvangbak of uiterlijk na verloop van de bedrijfstijd vermeld in de waarschuwing (**alleen bij partikelsnijden P5**).

1. Schakel de papiervernietiger uit met de aan-, uit-, stoptoets. Smeer de snijwalsen handmatig met olie in, (gebruik DAHLE-olie voor de papiervernietiger!).
2. Schakel de papiervernietiger aan met de aan-, uit-, stoptoets, laat het snijmechanisme zonder papiertoevoer 10 seconden achteruit lopen.



1. Schakel de papiervernietiger uit en haal de kabelstekker uit het stopcontact.
2. Reinig het apparaat uitsluitend met een droge doek.
3. Steek de kabelstekker in het stopcontact en schakel de papiervernietiger in.





**Headquarters:**

Novus Dahle GmbH  
Breslauer Straße 34-38  
DE-49808 Lingen (Ems)

**Service contact:**

Novus Dahle GmbH  
Nikolaus-A.-Otto-Straße 11  
96472 Rödental · Germany  
Tel.: +49 (0) 9563 75299-0  
Fax: +49 (0) 9563 75299-333  
[info@novus-dahle.com](mailto:info@novus-dahle.com)  
[www.novus-dahle.com](http://www.novus-dahle.com)